

6

DESTORNILLADORES
SCREWDRIVERS
TOURNEVIS
SCHRAUBENZIEHER
CACCIAVITI
CHAVES DE FENDA
OTBEPТKИ





Medalla
Salón Internacional
de la Invención
París 2007

Medal
International Inventors
Competition
Paris 2007

Medaille
Salon International
de l'Invention
Paris 2007

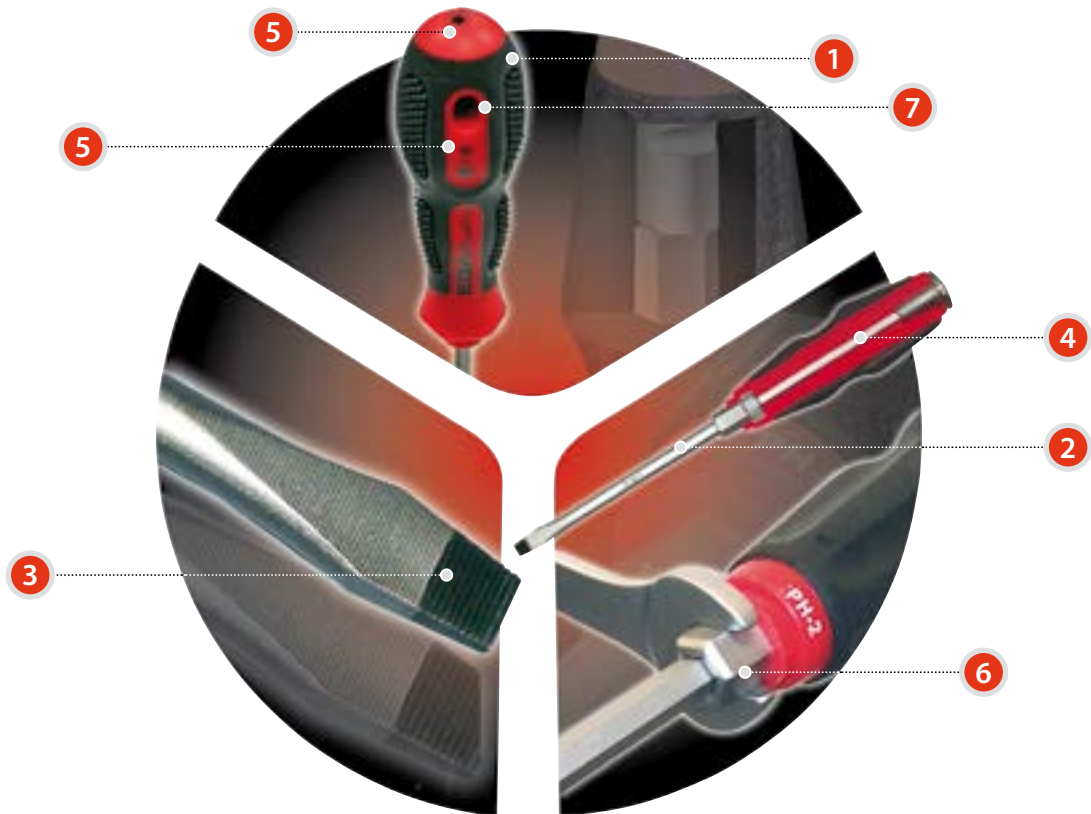

1
Equipados con mangos ergonómicos y antideslizantes más amplios, ofrecen un agarre superior evitando deslizamientos.
Oversized ergonomic & anti-slippery handles offer optimal grip for avoiding slippage.
Pourvus de manches ergonomiques et anti-dérapants plus volumineux.

2
Su varilla exclusiva de aleación cromo-molibdeno-vanadio permite aprietes un 30 % superiores a los destornilladores estándar.
Its exclusive chrome-molybdenum-vanadium alloy enables 30% higher tightening torque than traditional screwdrivers.
Sa lame "exclusivité" en alliage chrome molybdène vanadium, permet un serrage supérieur de 30% par rapport aux modèles standards.

3
Su innovador sistema de punta antideslizante y magnética facilita el posicionamiento y evita deslizamientos imprevistos.
The innovative "non-slip" anti-slippery and magnetic tip system allows an easier and safer positioning of the screwdriver, avoiding undesired slides.
Son système innovateur de tête anti-dérapante et magnétique, facilite le positionnement et fait éviter les dérapages.

4
Varilla pasante para el modelo Masterpunch, permite el golpeo en su parte superior.
Go-through bar enables hammering on the Masterpunch screwdriver's upper side.
Tige traversante pour le modèle Masterpunch, qui permet de frapper sur la partie supérieure.

5
El marcaje doble vertical y frontal de tipo y tamaño facilita la identificación rápida del destornillador que necesitamos emplear.
Type and size double marking of easy and efficient identification of the screwdriver to be used.

Le double marquage de type et de dimension facilite l'identification de l'outil recherché.

6
Modelos equipados con varilla hexagonal para aprietes con llaves.
Hexagonal bar screwdrivers available for strong tightening with wrenches.

Modèles pourvus de lames hexagonales pour le serrage avec une clé.

7
El agujero del mango permite apalancar.
Go-through hole in the handle enables tommy bar using.
Le trou sur le manche permet de serrer à l'aide d'une barre.

8
Patentado.
Patented.
Breveté.

06

DESTORNILLADORES
SCREWDRIVERS
TOURNEVIS
SCHRAUBENZIEHER
CACCIAVITI
CHAVES DE FENDA
ОТВЕРТКИ

EGA

MASTERTORK



Sistema de punta antideslizante NON-SLIP y magnética / *NON-SLIP antislippery magnetic tip* / NON-SLIP pointe brunie antidérapante et magnétique / *NON-SLIP Anti-Rutsch-Spitze*
Punta antiscivolo NON-SLIP / *Sistema de punta antideslizante de chave NON-SLIP* / Нескользкий магнитный наконечник

UTIL DE COMPROBACIÓN DE PAR DE DESTORNILLADORES RANURADOS / SLOTTED SCREWDRIVER TORQUE POWER TESTING TOOL / OUTIL DE VÉRIFICATION DE COUPLE DE TOURNEVIS AVEC RAINURE / SCHLITZSCHRAUBENDREHER DREHMOMENT LEISTUNGSTESTER / TEST CACCIAVITI / COMPROVADOR DE PAR PARA CHAVES DE FENDA / ТЕСТЕР КРУТЯЩЕГО МОМЕНТА ДЛЯ ПЛОСКИХ ОТВЕРТОК

COD.	L (mm)
64766	140



MECÁNICO / SLOTTED / MECANICIEN / FÜR SCHLITZSCHRAUBEN / PER MECCANICI / MECÂNICO / ПЛОСКАЯ

MM

COD.	A (mm)	B (mm)	Ø 1 (mm)	Ø 2 (mm)	L (mm)	L1 (mm)	L2 (mm)			
66400	3	0,5	3	26	165	80	85			
66401	4	0,8	4	26	185	100	85			
66402	5,5	1	5	34	205	100	105			
66403	6,5	1,2	6	36	230	125	105			
66404	8	1,5	7	40	240	125	115			
66405	8	1,2	7	40	265	150	115			
66406	8	1,2	7	40	280	150	115			
66407	9,5	1,6	8	40	330	200	130			
66408	10	2	8	40	330	200	130			
66409	12	2,5	10	40	380	250	130			
66449	13	2,5	10	40	380	250	130			
66410	14	2,5	10	40	380	250	130			

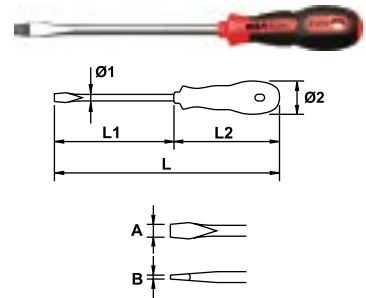

| DIN 5265 | Modelo registrado / Registered model / Modèle enregistré

INCH

COD.	A (inch)	B (inch)	Ø 1 (mm)	Ø 2 (mm)	L (mm)	L1 (inch)	L2 (mm)			
55330	1/8	0,02	3	26	165	3	85			
55331	5/32	0,032	4	26	185	4	85			
55328	3/16	0,04	5	34	205	5	105			
55332	7/32	0,04	5	34	230	5	105			
55333	7/32	0,04	5	34	240	5	105			
55334	1/4	0,046	6	36	240	6	115			
55335	1/4	0,046	6	36	265	6	115			
55336	5/16	0,046	7	40	280	6	115			
55337	5/16	0,046	7	40	280	6	115			
55338	3/8	0,063	8	40	330	8	130			
55339	25/64	0,063	8	40	330	8	130			
55329	7/16	0,08	10	40	380	10	130			
55340	15/32	0,08	10	40	380	10	130			
55341	1/2	0,098	10	40	380	10	130			

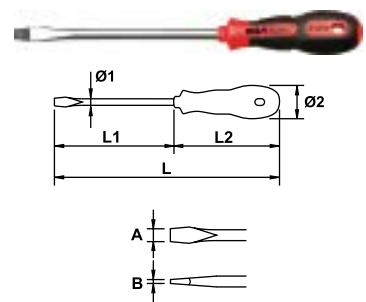

| DIN 5265 | Modelo registrado / Registered model / Modèle enregistré

06

DESTORNILLADORES
SCREWDRIVERS
TOURNEVIS
SCHRAUBENZIEHER
CACCIAVITI
CHAVES DE FENDA
ОТВЕРТКИ

EGA

MM

COD.	A (mm)	B (mm)	HEX 1 (mm)	HEX 2 (mm)	Ø 1 (mm)	L (mm)	L1 (mm)	L2 (mm)		
66413	4	0,8	4	-	26	185	100	85	16	
66414	5,5	1	5	-	34	230	125	105	8	
66415	6,5	1,2	6	-	36	240		115		I
66416	8			11		280	150			
66417	10	1,6	8		40	330	200	130	6	
66418	12	2				380				-
66419	14	2,5	10	16			250			

| DIN 5265 | Modelo registrado / Registered model / Modèle enregistré

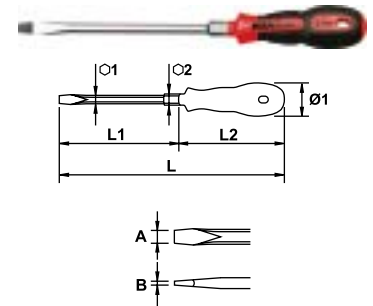

INCH

COD.	A (inch)	B (inch)	HEX 1 (mm)	HEX 2 (mm)	Ø 1 (mm)	L (mm)	L1 (inch)	L2 (mm)		
55344	5/32	0,032	4	-	26	185	4	85	16	
55345	7/32	0,04	5	-	34	230	5	105	8	
55346	1/4	0,046	6	-	36	240		115		I
55347	5/16			11		280	6			
55348	25/64	0,063	8		40	330	8	130	6	
55349	15/32	0,08	10	16		380	10			-

| DIN 5265 | Modelo registrado / Registered model / Modèle enregistré

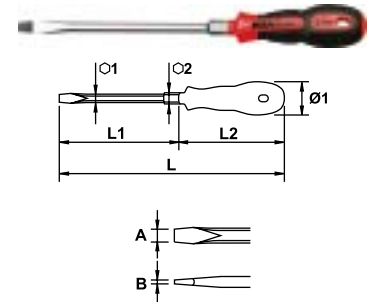

ELECTRICISTA / ELECTRICIAN / ELECTRICIEN / ELEKTRIK / PER ELETTRICISTI / ELETTRICISTA / ЭЛЕКТРИЧЕСКАЯ

MM

COD.	A (mm)	B (mm)	Ø 1 (mm)	Ø 2 (mm)	L (mm)	L1 (mm)	L2 (mm)			
66420	2,5	0,4	2,5		160	75				
66421				26	145	60	85	16		
66422	3	0,5	3		185	100				
66423					230	125				
66424	4	0,8	4		255	150				
66411				34	405	300	105	8	I	
66425					255	150				
66412	5,5	1	5,5		405	300				
66426	6,5	1,2	6,5	36	265	150	115	6		
66427	8		8	40	305	175	130	6		-

| DIN 5265 | Modelo registrado / Registered model / Modèle enregistré

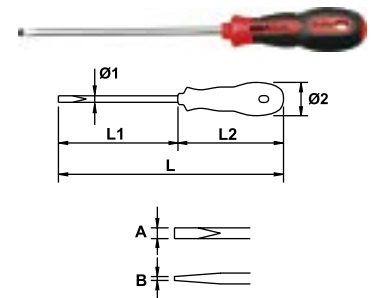

INCH

COD.	A (inch)	B (inch)	Ø 1 (mm)	Ø 2 (mm)	L (mm)	L1 (inch)	L2 (mm)			
55352	3/32	0,016	2,5	26	160	3	85	16		
55354	1/8	0,02	3		185	4				
55355					230	5				
55356	5/32	0,032	4		255	6				-
55357				34	405	12	105	8	I	
55358					255	6				
55359	7/32	0,04	5,5		405	12				
55360	1/4	0,046	6,5	36	265	6	115	6		-
55361	5/16	0,046	8	40	305	7	130	6		-

| DIN 5265 | Modelo registrado / Registered model / Modèle enregistré

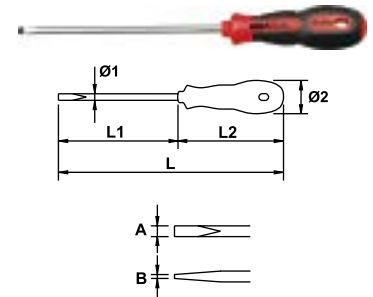







06

DESTORNILLADORES
SCREWDRIVERS
TOURNEVIS
SCHRAUBENZIEHER
CACCIAVITI
CHAVES DE FENDA
ОТВЕРТКИ

EGA

■ 1000V





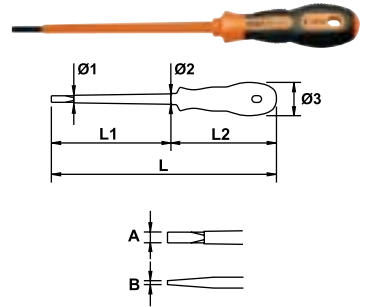

■ MM

COD.	A (mm)	B (mm)	Ø 1 (mm)	Ø 2 (mm)	Ø 3 (mm)	L (mm)	L1 (mm)	L2 (mm)			
76620	2,5	0,4	4,4	6,1	26	160	75	85	16		
76621	3	0,5	4,4	6,1	26	185	100	85	16		
76622	4	0,8	5,4	7		230	125	105	8	I	
76623	5,5	1	6,4	8,8	34	255					
76624	6,5	1,2	8,4	11	36	265	150	115			
76625	8	1,2	9,4	12,3	40	305	175	130	6		
76626	10	1,6	11,4	15	40	330	200	130	6		



 1000V | IEC 60900 | DIN 5265 | Modelo registrado / Registered model / Modèle enregistré





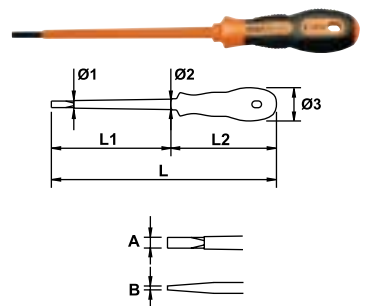



■ INCH

COD.	A (inch)	B (inch)	Ø 1 (mm)	Ø 2 (mm)	Ø 3 (mm)	L (mm)	L1 (inch)	L2 (mm)			
75063	3/32	0,016	4,4	6,1	26	160	3	85	16		
75064	1/8	0,02	4,4	6,1	26	185	4	85	16		
75065	5/32	0,032	5,4	7		230	5	105	8	I	
75066	7/32	0,04	6,4	8,8	34	255					
75067	7/32	0,04	6,4	8,8	34	255					
75068	1/4	0,046	8,4	11	36	265	6	115			
75069	5/16	0,046	9,4	12,3	40	305	7	130	6		
75081	25/64	0,063	11,4	15	40	330	8	130	6		



 1000V | IEC 60900 | DIN 5265 | Modelo registrado / Registered model / Modèle enregistré

■ PHILIPS

COD.		Ø 1 (mm)	Ø 2 (mm)	L (mm)	L1 (mm)	L2 (mm)			
66438	PH-0	3	26	145	60	85	16		
66439	PH-1	5	34	205	100	105	8		
66437	PH-1	5	34	405	300	105	8	I	
66440	PH-2	6	36	240	125	115			
66443	PH-2	6	36	415	300	115			
66441	PH-3	8	40	280	150	130	6		
66442	PH-4	10	40	330	200	130	6		

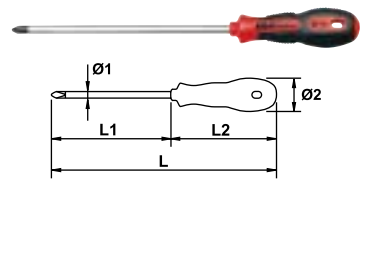





 DIN 5262 | Modelo registrado / Registered model / Modèle enregistré

06

DESTORNILLADORES
SCREWDRIVERS
TOURNEVIS
SCHRAUBENZIEHER
CACCIAVITI
CHAVES DE FENDA
OTBEPTKИ





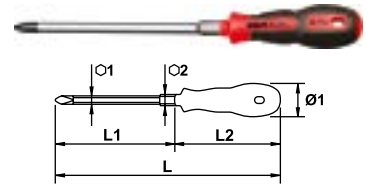

EGA

COD.		HEX 1 (mm)	HEX 2 (mm)	Ø 1 (mm)	L (mm)	L1 (mm)	L2 (mm)			
66444	PH-1	5	8	34	205	100	105	8		
66445	PH-2	6	11	36	240	125	115		I	
66446	PH-3	8		40	280	150	130	6		-
66447	PH-4	10	16		330	200				



 | DIN 5262 | Modelo registrado / Registered model / Modèle enregistré

■ 1000V



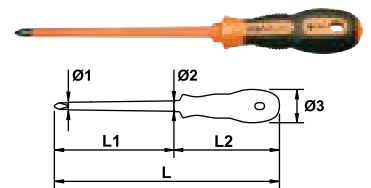

COD.		Ø 1 (mm)	Ø 2 (mm)	Ø 3 (mm)	L (mm)	L1 (mm)	L2 (mm)			
76628	PH-0	4,4	5	26	145	60	85	16		
76738	PH-1	6,4	7,6	34	185	80	105	8		
76629	PH-2	7,4	9,6	36	205	100	115		I	
76630	PH-3	9,4	12,3	40	240	125	130	6		-
76631	PH-4				280	150				
76632	PH-4				330	200				



 | 1000V | IEC 60900 | DIN 5262 | Modelo registrado / Registered model / Modèle enregistré

■ PLANO-PHILIPS PARA BORNES ELÉCTRICOS / SLOTTED-PHILIPS FOR TERMINAL SCREWS / PHILIPS-À FENTE POUR BORNES ÉLECTRIQUES / SCHLITZ-PHILIPS SCHRAUBENDREHER FÜR SCHRAUBKLEMMEN / TAGLIO-PHILIPS PER TERMINALI ELETTRICI / FENDA-PHILIPS PARA BORNES ELÉCTRICOS / ОТВЕРТКА КРЕСТОВАЯ КЛЕМНАЯ PH





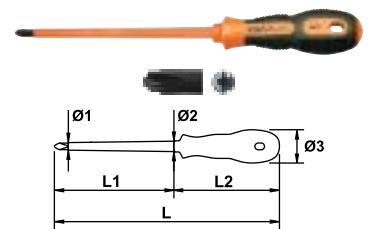



■ 1000V

COD.		Ø 1 (mm)	Ø 2 (mm)	Ø 3 (mm)	L (mm)	L1 (mm)	L2 (mm)		
79163	 PH-1	6,4	7,6	34	205	100	105	8	
79164	 PH-2	7,4	9,6	36	240	125	115	6	I



 | 1000V | IEC 60900 | Modelo registrado / Registered model / Modèle enregistré

■ POZIDRIV®*

COD.		Ø 1 (mm)	Ø 2 (mm)	L (mm)	L1 (mm)	L2 (mm)			
66456	PZ-0	3	26	145	60	85	16		
66457	PZ-1	5	34	205	100	105	8		
66472	PZ-2	6	36	405	300	115		I	
66458	PZ-2	6	36	240	125	115			
66473	PZ-2	6	36	415	300		6		
66459	PZ-3	8	40	280	150	130			
66460	PZ-4	10		330	200				

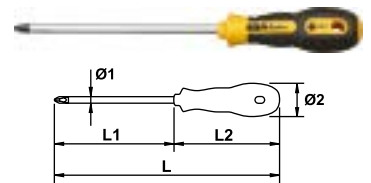

 | DIN 5262 | Modelo registrado / Registered model / Modèle enregistré

*Para tornillos POZIDRIV® (Marca registrada por European Ind. Serv. Ltd.) / *For screws POZIDRIV® (European Ind. Serv. Ltd. registered trademark) / *Pour vis POZIDRIV® (Marque enregistrée par European Ind. Serv. Ltd.)

06

DESTORNILLADORES
SCREWDRIVERS
TOURNEVIS
SCHRAUBENZIEHER
CACCIAVITI
CHAVES DE FENDA
ОТВЕРТКИ

EGA

COD.		HEX 1 (mm)	HEX 2 (mm)	Ø 1 (mm)	L (mm)	L1 (mm)	L2 (mm)		
66462	PZ-1	5	8	34	205	100	105	8	
66463	PZ-2	6	11	36	240	125	115		1
66464	PZ-3	8		40	278	150	128	6	
66465	PZ-4	10	16		328	200			

| DIN 5262 | Modelo registrado / Registered model / Modèle enregistré

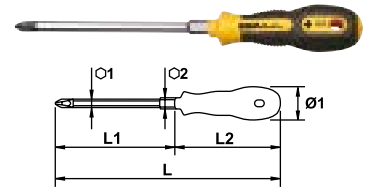

1000V

COD.		Ø 1 (mm)	Ø 2 (mm)	Ø 3 (mm)	L (mm)	L1 (mm)	L2 (mm)			
76633	PZ-0	4,4	5	26	145	60	85	16		
76634	PZ-1	6,4	7,6	34	205	100	105	8		
76635	PZ-2	7,4	9,6	36	240	125	115		1	
76636	PZ-3	9,4	12,3	40	280	150	130	6		
76637	PZ-4				330	200				

| 1000V | IEC 60900 | DIN 5262 | Modelo registrado / Registered model / Modèle enregistré

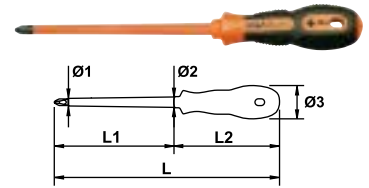

PLANO-POZIDRIV PARA BORNES ELÉCTRICOS / SLOTTED-POZIDRIV** FOR TERMINAL SCREWS / POZIDRIV** - À FENTE POUR BORNES ÉLECTRIQUES / SCHLITZ-POZIDRIV** SCHRAUBENDREHER FÜR SCHRAUBKLEMMEN / TAGLIO-POZIDRIV** PER TERMINALI ELETTRICI / FENDA-POZIDRIV** PARA BORNES ELÉCTRICOS / ОТВЕРТКА КРЕТОВАЯ КЛЕМНАЯ POZIDRIV****

1000V

COD.		Ø 1 (mm)	Ø 2 (mm)	Ø 3 (mm)	L (mm)	L1 (mm)	L2 (mm)		
79165	PZ-1	6,4	7,6	34	205	100	105	8	
79166	PZ-2	7,4	9,6	36	240	125	115	6	1

| 1000V | IEC 60900 | Modelo registrado / Registered model / Modèle enregistré

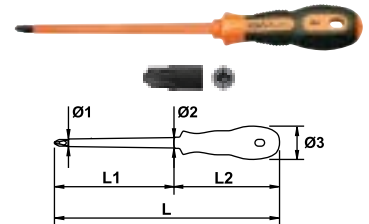

TORX**

COD.		Ø 1 (mm)	Ø 2 (mm)	L (mm)	L1 (mm)	L2 (mm)			
66474	T-6								
66475	T-7			135	50				
66476	T-8	3	26			85			
66477	T-9			160	75			16	
66478	T-10			180					
66479	T-15	4							1
66480	T-20		34	205	100	105			
66481	T-25	5		220	115			8	
66482	T-27			240	125	115			
66483	T-30	6	36	240	125	115			
66484	T-40	7		255					
66485	T-45	8	40	280	150	130	6		
66486	T-50	10		305	175				

| DIN 5262 | Modelo registrado / Registered model / Modèle enregistré

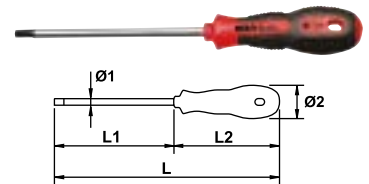







*Para tornillos POZIDRIV® (Marca registrada por European Ind. Serv. Ltd.) / *For screws POZIDRIV® (European Ind. Serv. Ltd. registered trademark) / *Pour vis POZIDRIV® (Marque enregistrée par European Ind. Serv. Ltd.)
*Para tornillos TORX® (Marca registrada por Acument Intellectual Properties, LLC, Troy, Mich., US) / *For screws TORX® (Acument Intellectual Properties, LLC, Troy, Mich., US registered trademark) / *Pour vis TORX® (Marque enregistrée par Acument Intellectual Properties, LLC, Troy, Mich., US)

06

DESTORNILLADORES
SCREWDRIVERS
TOURNEVIS
SCHRAUBENZIEHER
CACCIAVITI
CHAVES DE FENDA
OTBEPTKИ

EGA



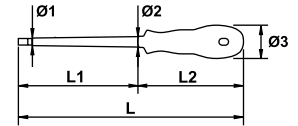

1000V

COD.		Ø 1 (mm)	Ø 2 (mm)	Ø 3 (mm)	L (mm)	L1 (mm)	L2 (mm)			
76638	T-6		8		135	50				
76639	T-7									
76640	T-8	4,4		26			85			
76641	T-9		5		160			16		
76642	T-10					75				
76643	T-15				180					
76644	T-20	5,8	8		205	100	105			
76645	T-25			34						
76646	T-27	6,4			220	115		8		
76647	T-30	7,4	9,6		240		115			
76648	T-40	8,7		36		125				
76649	T-45	9,4	12,3	40	280	150	128	6		
76650	T-50	11,4	15		305	175				



 1000V | IEC 60900 | DIN 5262 | Modelo registrado / Registered model / Modèle enregistré

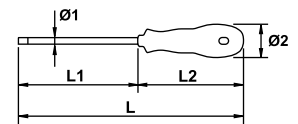

TAMPER TORX

COD.		Ø 1 (mm)	Ø 2 (mm)	L (mm)	L1 (mm)	L2 (mm)			
66487	TT-6			135	50				
66488	TT-7								
66489	TT-8	3							
66490	TT-9		26			85	16		
66491	TT-10			160	75				
66492	TT-15	4							
66493	TT-20			185	100				
66494	TT-25	5	34	205		105			
66495	TT-27			220	115		8		
66496	TT-30	6	36	240	125	115			
66497	TT-40	7		255					
66498	TT-45	8	40	280	150	130	6		
66499	TT-50	10		305	175				



 | Modelo registrado / Registered model / Modèle enregistré

1000V

COD.		Ø 1 (mm)	Ø 2 (mm)	Ø 3 (mm)	L (mm)	L1 (mm)	L2 (mm)		
75037	TT-6		8		135	50			
75038	TT-7								
75039	TT-8	4,4		26			85		
75040	TT-9		5		160			16	
75041	TT-10					75			
75042	TT-15				180				
75043	TT-20	5,8	8		205	100	105		
75044	TT-25			34					
75045	TT-27	6,4			220	115		8	
75046	TT-30	7,4	9,6		240		115		
75047	TT-40	8,7		36		125			
75048	TT-45	9,4	12,3	40	280	150	128	6	
75049	TT-50	11,4	15		305	175			

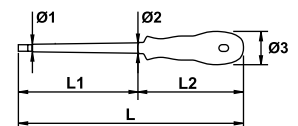

 1000V | IEC 60900 | Modelo registrado / Registered model / Modèle enregistré

06

DESTORNILLADORES
SCREWDRIVERS
TOURNEVIS
SCHRAUBENZIEHER
CACCIAVITI
CHAVES DE FENDA
ОТВЕРТКИ

EGA

■ **PUNTA ESFERA / BALL TIP / TÊTE SPHÉRIQUE / KUGELKOPF / TESTA SFERICA / PONTA ESFERICA / С ШАРОВОЙ ГОЛОВКОЙ**

■ **MM**

COD.	HEX 1 (mm)	Ø 1 (mm)	L (mm)	L1 (mm)	L2 (mm)			
66501	2,5		160	75				
66502	3	26	185	100	85	16		
66503	4		205	100			I	
66504	5	34	230	125	105	8		
66505	6	36	280	150	130	6		
66506	8	40						
66507	10							

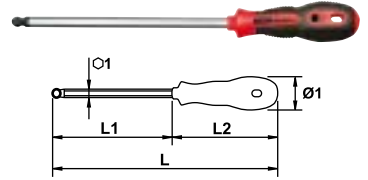

| Modelo registrado / Registered model / Modèle enregistré

■ **INCH**

COD.	HEX 1 (inch)	Ø 1 (mm)	L (mm)	L1 (inch)	L2 (mm)			
55364	1/8		160	3	85	16		
55365	5/32	26	185	4	105	8	I	
55362	13/64	34	230	6	130	6		
55368	5/16	40						
55369	25/64							

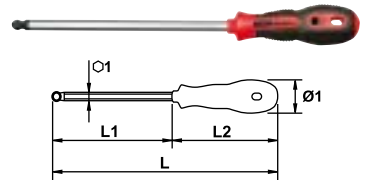

| Modelo registrado / Registered model / Modèle enregistré

■ **HEXAGONAL ALLEN**

■ **1000V**

■ **MM**

COD.		Ø 1 (mm)	Ø 2 (mm)	Ø 3 (mm)	L (mm)	L1 (mm)	L2 (mm)		
74710	2,5	4,4	6	26	160	75	85	16	
74711	3				185	100		8	I
74712	4	5,8	8	34	205	125	105	6	
74713	5	6,4			230	150	130		
74714	6	7,8	11,2	40	280				
74715	8	9,8	13,4						

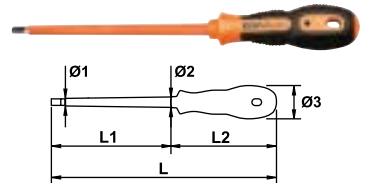

| Modelo registrado / Registered model / Modèle enregistré

■ **INCH**

COD.		Ø 1 (mm)	Ø 2 (mm)	Ø 3 (mm)	L (mm)	L1 (inch)	L2 (mm)		
75083	1/8	4,4	6	26	160	3	85	16	
75084	5/32	5,8	8	34	185	4	105	8	I
75131	13/64	6,4			205	6	130	6	
75097	5/16	9,8	13,4						

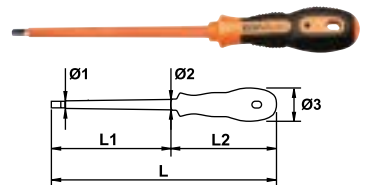





| Modelo registrado / Registered model / Modèle enregistré

06

DESTORNILLADORES
SCREWDRIVERS
TOURNEVIS
SCHRAUBENZIEHER
CACCIAVITI
CHAVES DE FENDA
ОТВЕРТКИ

EGA

ROBERTSON

COD.		 AF (mm)	Ø 1 (mm)	Ø 2 (mm)	L (mm)	L1 (mm)	L2 (mm)			
66530	1	2,4	4	26	185	100	85	16		
66531	2	2,8	5	34	230	125	105	8	I	●
66532	3	3,4	6	36	265	150	115	6		●

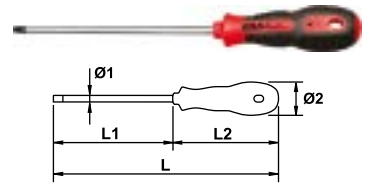



 Modelo registrado / Registered model / Modèle enregistré

CARROCERO / STUBBY / TOM POUCE / SCHRAUBENDREHER, KURZE FORM / CACCIAVITI NANI / COTOS / КОРОТКАЯ

ELECTRICISTA / ELECTRICIAN / ELECTRICIEN / ELEKTRIK / PER ELETTRICISTI / ELETRECISTA / ЭЛЕКТРИЧЕСКАЯ

MM



COD.	A (mm)	B (mm)	Ø 1 (mm)	Ø 2 (mm)	L (mm)	L1 (mm)	L2 (mm)		
66525	5,5	1,2	5,5	40	85	25	60	20	I

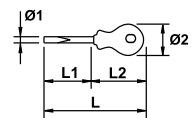

 DIN 5265  Modelo registrado / Registered model / Modèle enregistré



INCH



COD.	A (inch)	B (inch)	Ø 1 (mm)	Ø 2 (mm)	L (mm)	L1 (inch)	L2 (mm)		
55371	7/32	0,046	5,5	40	85	1	60	20	I

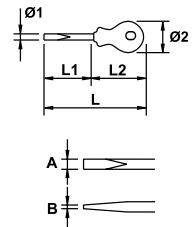

 DIN 5265  Modelo registrado / Registered model / Modèle enregistré



PHILIPS



COD.		Ø 1 (mm)	Ø 2 (mm)	L (mm)	L1 (mm)	L2 (mm)		
67192	PH-1	5	40	85	25	60	20	I
66526	PH-2	6	40	85	25	60	20	I

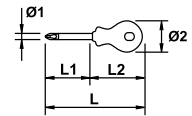

 DIN 5262  Modelo registrado / Registered model / Modèle enregistré



POZIDRIV**

COD.		Ø 1 (mm)	Ø 2 (mm)	L (mm)	L1 (mm)	L2 (mm)		
67193	PZ-1	5	40	85	25	60	20	I
66527	PZ-2	6	40	85	25	60	20	I



 DIN 5262  Modelo registrado / Registered model / Modèle enregistré

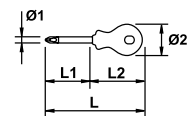

*Para tornillos POZIDRIV® (Marca registrada por European Ind. Serv. Ltd.) / *For screws POZIDRIV® (European Ind. Serv. Ltd. registered trademark) / *Pour vis POZIDRIV® (Marque enregistrée par European Ind. Serv. Ltd.)



06

DESTORNILLADORES
SCREWDRIVERS
TOURNEVIS
SCHRAUBENZIEHER
CACCIAVITI
CHAVES DE FENDA
ОТВЕРТКИ

EGA

DE VASO / SOCKET SCREWDRIVER / CLÉ À DOUILLE EMMANCHÉE / 6-KANT STECKSCHLÜSSEL / BUSSOLE / DE CAIXA / ОТВЕРТКА С ГОЛОВКОЙ

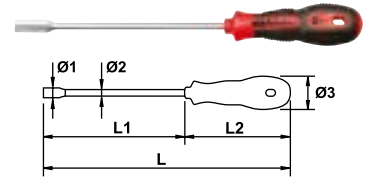

MM

COD.		Ø 1 (mm)	Ø 2 (mm)	Ø 3 (mm)	L (mm)	L1 (mm)	L2 (mm)		
66510	4	8							
66511	5	8,5	5	34	255	150	105	8	
66512	5,5								
66513	6								
66509	6,5	10	6	36	275	160	115		
66514	7	11			290				
66515	8	14							1
66516	9		8					6	
66517	10	15				175			
66518	11	17		40	305		130		
66519	12								
66520	13	19	9						
66521	14	20							



 Modelo registrado / Registered model / Modèle enregistré

INCH

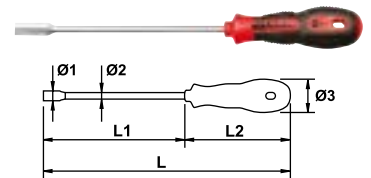

COD.		Ø 1 (mm)	Ø 2 (mm)	Ø 3 (mm)	L (mm)	L1 (inch)	L2 (mm)		
55373	5/32	8							
55374	3/16	8,5	5	34	255	6	105	8	
55375	7/32								
55376	1/4	10	6	36	275		115		
55378	5/16		8						
55379	11/32	14	7						1
55372	3/8		8					6	
55380	25/64	15		40	305	7	130		
55385	7/16	20							
55382	15/32	17	9						
55383	1/2	19	7						



 Modelo registrado / Registered model / Modèle enregistré

1000V

MM

COD.		Ø 1 (mm)	Ø 2 (mm)	Ø 3 (mm)	L (mm)	L1 (mm)	L2 (mm)		
74698	4								
74699	5	11	7,5	34	255	150	105	8	
74700	5,5								
74701	6								
74701	6	12,5	8,5	36	275	160	115		
74702	7				290				
74703	8								1
74704	9	16	10,5					6	
74705	10					175			
74706	11			40	305		130		
74707	12	19							
74708	13		11,5						
74709	14	21							

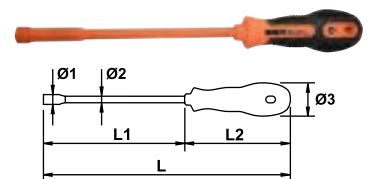



 1000V | IEC 60900 | Modelo registrado / Registered model / Modèle enregistré

06

DESTORNILLADORES
SCREWDRIVERS
TOURNEVIS
SCHRAUBENZIEHER
CACCIAVITI
CHAVES DE FENDA
OTBEPTKИ

EGA





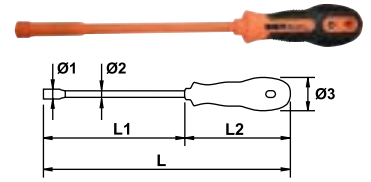

INCH

COD.		Ø 1 (mm)	Ø 2 (mm)	Ø 3 (mm)	L (mm)	L1 (inch)	L2 (mm)		
75132	5/32								
74984	3/16	11	7,5	34	255	6	105	8	
75133	7/32								
74985	1/4	12,5	8,5	36	275		115		
74986	5/16								
74987	3/8	16	10,5						I
75136	25/64			40	305	7	130	6	
74988	7/16	19							
75138	15/32		11,5						
74989	1/2	21							



 1000V | IEC 60900 | Modelo registrado / Registered model / Modèle enregistré







MM

COD.						
74664	9					
74665	10					
74666	11	11	130	115	6	I
74667	12					
74669	14					
74670	17					



 1000V | IEC 60900

INCH

COD.						
74671	3/16					
74672	1/4					
74673	5/16					
74674	3/8	11	5	115	6	I
74675	7/16					
74676	1/2					
74677	9/16					
74678	5/8					





 1000V | IEC 60900

T - MASTERTORK

HEXAGONAL ALLEN

MM

COD.		L (mm)	L1 (mm)	L2 (mm)	L3 (mm)		
66571	2,5						
66572	3	165	125	40	60	16	
66573	4						I
66574	5						
66575	6	200	150	50	80	8	
66576	8	240	175	65	100	6	-
66577	10	265	200				

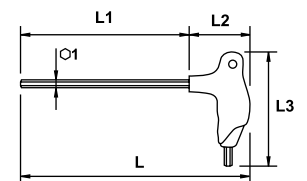



06

DESTORNILLADORES
SCREWDRIVERS
TOURNEVIS
SCHRAUBENZIEHER
CACCIAVITI
CHAVES DE FENDA
OTBEPTKИ



EGA

INCH

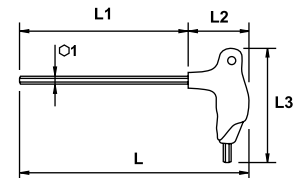
COD.		L (mm)	L1 (inch)	L2 (mm)	L3 (mm)		
55387	1/8	165	5	40	60	16	I
55388	5/32						
55390	1/4	200	6	50	80	8	
55391	5/16	240	7	65	100	6	-
55392	25/64	265	8				



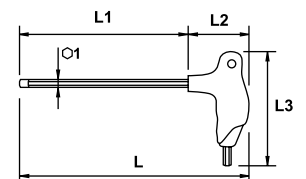

TORX®*

COD.		HEX 1 (mm)	L (mm)	L1 (mm)	L2 (mm)	L3 (mm)		
66581	T-6	3	165	125	40	60	16	I
66582	T-7							
66583	T-8							
66584	T-9	3,5	200	150	50	80	8	
66585	T-10							
66586	T-15							
66587	T-20							
66588	T-25	4,5	240	175	65	100	6	-
66589	T-27	5,5						
66590	T-30	6						
66591	T-40	7	240	175	65	100	6	-
66592	T-45	8						
66593	T-50	9						



DE VASO / SOCKET SCREWDRIVER / CLÉ À DOUILLE EMMANCHÉE / 6-KANT STECKSCHLÜSSEL / BUSSOLE / DE CAIXA / ОТВЕРТКА С ГОЛОВКОЙ

MM

COD.		Ø 1 (mm)	Ø 2 (mm)	L (mm)	L1 (mm)	L2 (mm)	L3 (mm)		
66596	5	8,5	5	200	150	50	80	8	
66597	6	10	6	210	160				
66598	7	11	8	240	175	65	100	6	I
66599	8	13							
66600	9	14							
66601	10	15	9	240	175	65	100	6	
66602	11	17							
66603	12	19							

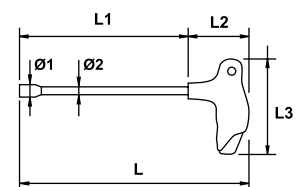



*Para tornillos TORX® (Marca registrada por Acument Intellectual Properties, LLC, Troy, Mich., US) / *For screws TORX® (Acument Intellectual Properties, LLC, Troy, Mich., US registered trademark) / *Pour vis TORX® (Marque enregistrée par Acument Intellectual Properties, LLC, Troy, Mich., US)

06

DESTORNILLADORES
SCREWDRIVERS
TOURNEVIS
SCHRAUBENZIEHER
CACCIAVITI
CHAVES DE FENDA
ОТВЕРТКИ

EGA

INCH

COD.		Ø 1 (mm)	Ø 2 (mm)	L (mm)	L1 (mm)	L2 (mm)	L3 (mm)		
55397	5/16	13	8	240	7	65	100	6	I
55399	25/64	15	8	240	7	65	100	6	I
55401	15/32	17	9	240	7	65	100	6	I

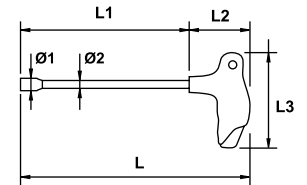

MASTERPUNCH - ALL THROUGH





Sistema de punta antideslizante **NON-SLIP** y magnética / *NON-SLIP antislippery magnetic tip* / **NON-SLIP** pointe brunie antidérapante et magnétique / *NON-SLIP Anti-Rutsch-Spitze*
Punta antiscivolo **NON-SLIP** / Sistema de ponta antideslizante de chave **NON-SLIP** / Нескользкий магнитный наконечник



Varilla pasante, permite el golpeo en su parte superior / *Go-through bar enables hammering on the screwdriver's upper side* / Tige traversante permettant le frapper sur la partie supérieure du manche / *Vorstecker mit Schlagfesten Griff* / Cacciavite a lame passante a battere / Chave de fenda - haste interna, permite pancada na sua parte superior / Проходящий через ручку стержень позволяет наносить удары по верхней части отвертки

MECÁNICO / SLOTTED / MECANICIEN / FÜR SCHLITZSCHRAUBEN / PER MECCANICI / MECÂNICO / ПЛОСКАЯ



MM

COD.	A (mm)	B (mm)	HEX 1 (mm)	HEX 2 (mm)	Ø 1 (mm)	L (mm)	L1 (mm)	L2 (mm)		
66551	6,5	1,2	6	11	35	235	125	110	6	I
66552	8	1,2	6	11	35	270	150	120	6	I
66553	10	1,6	8	11	39	295	175	120	6	I

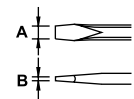
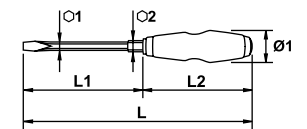
 DIN 5265





INCH

COD.	A (inch)	B (inch)	HEX 1 (mm)	HEX 2 (mm)	Ø 1 (mm)	L (mm)	L1 (inch)	L2 (mm)		
55405	5/16	0,046	8	11	39	270	6	120	6	I
55406	25/64	0,063	8	11	39	295	7	120	6	I

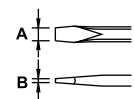
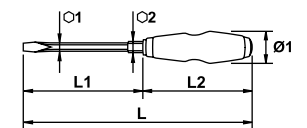
 DIN 5265



PHILIPS

COD.		HEX 1 (mm)	HEX 2 (mm)	Ø 1 (mm)	L (mm)	L1 (mm)	L2 (mm)		
66559	PH-2	6	11	35	235	125	110	6	I
66560	PH-3	8	11	39	270	150	120	6	I

 DIN 5262

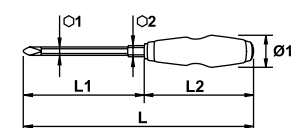



06

DESTORNILLADORES
SCREWDRIVERS
TOURNEVIS
SCHRAUBENZIEHER
CACCIAVITI
CHAVES DE FENDA
ОТВЕРТКИ

EGA

POZIDRIV®*

COD.		HEX 1 (mm)	HEX 2 (mm)	Ø 1 (mm)	L (mm)	L1 (mm)	L2 (mm)		
66565	PZ-2	6		35	235	125	110	6	I
66566	PZ-3	8	11	39	270	150	120		



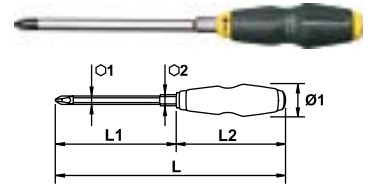

  | DIN 5262



ROTORK

MECÁNICO / SLOTTED / MECANICIEN / FÜR SCHLITZSCHRAUBEN / PER MECCANICI / MECÂNICO / ПЛОСКАЯ



MM

COD.	A (mm)	B (mm)	Ø 1 (mm)	Ø 2 (mm)	L (mm)	L1 (mm)	L2 (mm)			
66874	3	0,5	3		155	80	75	16		
66875	4	0,8	4		175	100	75			
66876					205					
66877	5,5	1	5							
66878				31	230	125	105			
66879	6,5		6		255	150		8	I	
66880		1,2			268					
66881	8		7				118			
66882	10	1,6	8							
67102	12	2		35	318	200		6		
67103	14	2,5	10		365	250	115			

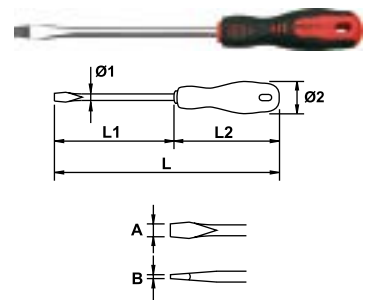
 | DIN 5265



INCH

COD.	A (inch)	B (inch)	Ø 1 (mm)	Ø 2 (mm)	L (mm)	L1 (inch)	L2 (mm)		
55408	1/8	0,02	3		155	3	75	16	
55409	5/32	0,032	4		175	4	75		
55410					205				
55411	7/32	0,04	5			5	105		
55413	1/4		6		255	6		8	I
55414		0,046			268				
55415	5/16		7				118		
55416	25/64	0,063	8		318	8		6	
55417	15/32	0,080	10		365	10	115		

 | DIN 5265

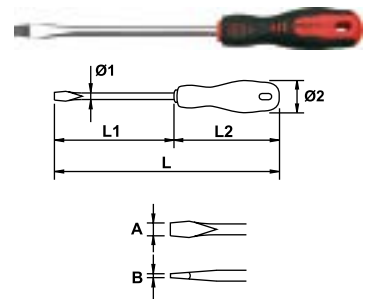

*Para tornillos POZIDRIV® (Marca registrada por European Ind. Serv. Ltd.) / *For screws POZIDRIV® (European Ind. Serv. Ltd. registered trademark) / *Pour vis POZIDRIV® (Marque enregistrée par European Ind. Serv. Ltd.)

06

DESTORNILLADORES
SCREWDRIVERS
TOURNEVIS
SCHRAUBENZIEHER
CACCIAVITI
CHAVES DE FENDA
ОТВЕРТКИ

EGA

MM

COD.	A (mm)	B (mm)	HEX 1 (mm)	HEX 2 (mm)	Ø 1 (mm)	L (mm)	L1 (mm)	L2 (mm)		
67104	4	0,8	4	-	22	175	100	75	16	
67105	5,5	1	5	-	31	230	125	105	8	
66883	6,5	1,2	6	11		240				
66884	8					265	150			I
66885	10	1,6	8	-	35	315	200	115	6	
67106	12	2				365	250			
67107	14	2,5	10							

DIN 5265

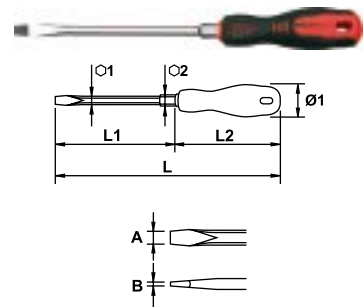

INCH

COD.	A (inch)	B (inch)	HEX 1 (mm)	HEX 2 (mm)	Ø 1 (mm)	L (mm)	L1 (inch)	L2 (mm)		
55420	5/32	0,032	4	-	22	175	4	75	16	
55421	7/32	0,04	5	-	31	230	5	105	8	
55423	5/16	0,046	8	11		268	6			I
55424	25/64	0,063	8		35	318	8	115	6	
55425	15/32	0,08	10	-		368	10			

DIN 5265

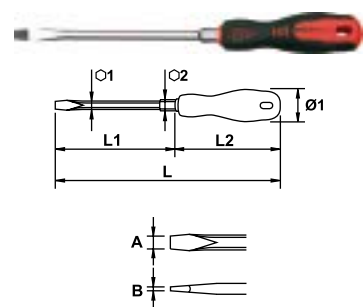

ELECTRICISTA / ELECTRICIAN / ELECTRICIEN / ELEKTRIK / PER ELETTRICISTI / ELETRECISTA / ЭЛЕКТРИЧЕСКАЯ

MM

COD.	A (mm)	B (mm)	Ø 1 (mm)	Ø 2 (mm)	L (mm)	L1 (mm)	L2 (mm)			
67149	2,5	0,4	2,5		135	60				
66886	3	0,5	3	22	175	100	75	16		●
66887					200	125				
66888	4	0,8	4		225	150				
66889					255					I
66890	5	1	5	31	305	200	105	8		●
66891					255	150				
66892	6	1,2	6		255	150				●
67108	8		8	35	290	175	115	6		
67109	10	1,6	10		315	200				-

DIN 5265

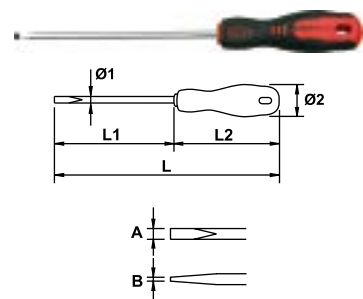

INCH

COD.	A (inch)	B (inch)	Ø 1 (mm)	Ø 2 (mm)	L (mm)	L1 (inch)	L2 (mm)			
55428	3/32	0,016	2,5		135	2				
55429	1/8	0,02	3	22	175	4	75	16		●
55430					200	5				
55431	5/32	0,032	4		225	6				
55432					255					I
55433	3/16	0,04	5	31	305	8	105	8		
55434					255	6				-
55435	1/4	0,046	6		255	6				
55436	5/16	0,063	8	35	290	7	115	6		
55437	25/64	0,063	10		315	8				

DIN 5265

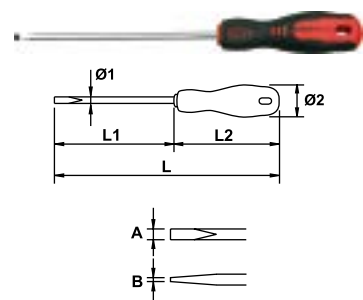







06

DESTORNILLADORES
SCREWDRIVERS
TOURNEVIS
SCHRAUBENZIEHER
CACCIAVITI
CHAVES DE FENDA
OTBEPTKИ

EGA

■ 1000V



■ MM

COD.	A (mm)	B (mm)	Ø 1 (mm)	Ø 2 (mm)	Ø 3 (mm)	L (mm)	L1 (mm)	L2 (mm)			
76730	2,5	0,4	4,4	6,1	22	135	60	75	16		
76731	3	0,5	4,4	6,1	22	175	100				
76651	4	0,8	5,4	7	31	230	125				
76652	5,5	1	6,4	8,8	31	255	150	105	8	I	
76653	6,5	1,2	7,8	11	35	290	175				-
76654	8	1,2	9,4	12,3	35	290	175	115	6		-
76732	10	1,6	11,4	15	35	315	200				-
76733											

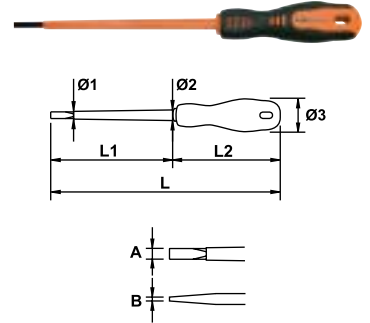
  1000V | IEC 60900 | DIN 5265







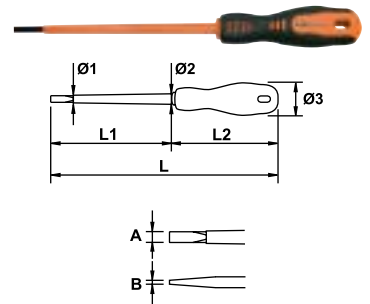

■ INCH

COD.	A (inch)	B (inch)	Ø 1 (mm)	Ø 2 (mm)	Ø 3 (mm)	L (mm)	L1 (inch)	L2 (mm)		
75172	3/32	0,016	4,4	6,1	22	135	2	75	16	
75173	1/8	0,02	4,4	6,1	22	175	4			
75174	5/32	0,032	5,4	7	31	230	5			
75175	3/16	0,04	6,4	8,8	31	255	6	105	8	I
75176	1/4	0,046	7,8	11	35	290	7			
75177	5/16	0,063	9,4	12,3	35	290	7	115	6	
75178	25/64	0,063	11,4	15	35	315	8			
75179										

  1000V | IEC 60900 | DIN 5265





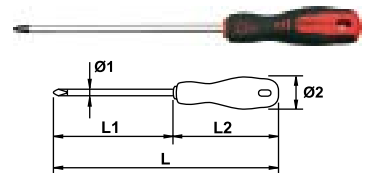

■ PHILIPS

COD.		Ø 1 (mm)	Ø 2 (mm)	L (mm)	L1 (mm)	L2 (mm)			
66897	PH-0	3	22	135	60	75	16		
66898	PH-1	4	31	205	100	105	8		-
66899	PH-2	5	31	230	125	105	8	I	
66900	PH-3	6	35	265	150	115	6		
67131	PH-4	10	35	315	200	115	6		-

DIN 5262







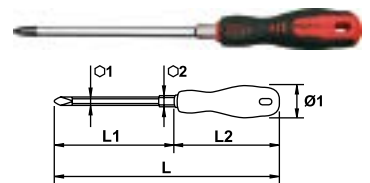

COD.		HEX 1 (mm)	HEX 2 (mm)	Ø 1 (mm)	L (mm)	L1 (mm)	L2 (mm)			
67053	PH-1	5	-	31	205	100	105	8		
66901	PH-2	6	-	31	243	125	105	8		-
66902	PH-3	8	11	35	268	150	118	6	I	-
67054	PH-4	8	11	35	318	200	118	6		-

  | DIN 5262



■ 1000V

COD.		Ø 1 (mm)	Ø 2 (mm)	Ø 3 (mm)	L (mm)	L1 (mm)	L2 (mm)			
76655	PH-0	4,4	5	22	135	60	75	16		
76656	PH-1	6,4	8	31	205	100	105	8		
76657	PH-2	7,4	9,6	31	230	125	105	8	I	-
76658	PH-3	9,4	12,3	35	268	150	118	6		-
76735	PH-4	11,4	15	35	318	200	118	6		-

  1000V | IEC 60900 | DIN 5262

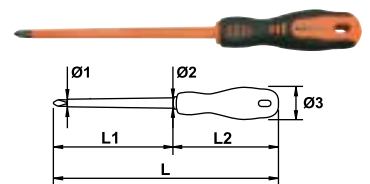







06

DESTORNILLADORES
SCREWDRIVERS
TOURNEVIS
SCHRAUBENZIEHER
CACCIAVITI
CHAVES DE FENDA
OTBEPTKИ





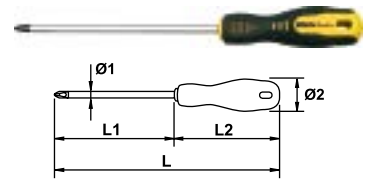

EGA

POZIDRIV®*

COD.		Ø 1 (mm)	Ø 2 (mm)	L (mm)	L1 (mm)	L2 (mm)			
66907	PZ-0	3	22	135	60	75	16		
66908	PZ-1	5		205	100				
66909	PZ-2	6	31	230	125	105	8	I	
66910	PZ-3	8		268	150				-
67064	PZ-4	10	35	318	200	118	6		-

DIN 5262





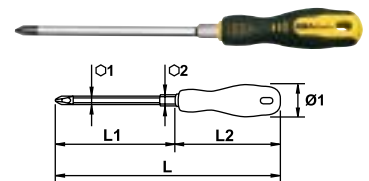

COD.		HEX 1 (mm)	HEX 2 (mm)	Ø 1 (mm)	L (mm)	L1 (mm)	L2 (mm)			
67167	PZ-1	5	-		215	100		8		
66911	PZ-2	6		35	240	125	115		I	
66912	PZ-3	8	11		265	150		6		-
67168	PZ-4				315	200				-

  | DIN 5262









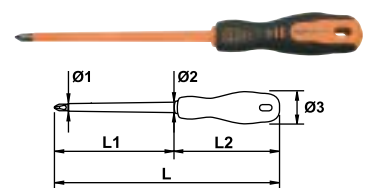



1000V

COD.		Ø 1 (mm)	Ø 2 (mm)	Ø 3 (mm)	L (mm)	L1 (mm)	L2 (mm)		
76659	-	PZ-0	4,4	5	22	135	60	75	16
76660		PZ-1	6,4	8	31	205	100	105	8
76661		PZ-2	7,4	9,6	35	230	125	118	6
76662		PZ-3	9,4	12,3	35	268	150	118	6
76736	-	PZ-4	12,5		318	200			

 1000V | IEC 60900 | DIN 5262



TORX®*

COD.		Ø 1 (mm)	Ø 2 (mm)	L (mm)	L1 (mm)	L2 (mm)			
66917	T-6								
66918	T-7	3		125	50				
66919	T-8								
66920	T-9		22			75	16		-
66921	T-10	4		150	75				-
66922	T-15								
66923	T-20			175	100			I	
66924	T-25	5		205					-
66925	T-27	6	31	220	115	105	8		
66926	T-30			230	125				-
66927	T-40	7		240					-
67183	T-45	8	35	265	150	115	6		-
67184	T-50	10		290	175				-

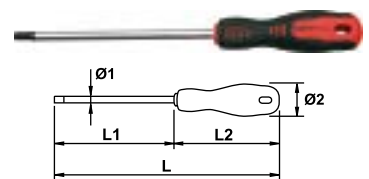





*Para tornillos POZIDRIV® (Marca registrada por European Ind. Serv. Ltd.) / *For screws POZIDRIV® (European Ind. Serv. Ltd. registered trademark) / *Pour vis POZIDRIV® (Marque enregistrée par European Ind. Serv. Ltd.)
*Para tornillos TORX® (Marca registrada por Acument Intellectual Properties, LLC, Troy, Mich., US) / *For screws TORX® (Acument Intellectual Properties, LLC, Troy, Mich., US registered trademark) / *Pour vis TORX® (Marque enregistrée par Acument Intellectual Properties, LLC, Troy, Mich., US)



06

DESTORNILLADORES
SCREWDRIVERS
TOURNEVIS
SCHRAUBENZIEHER
CACCIAVITI
CHAVES DE FENDA
ОТВЕРТКИ

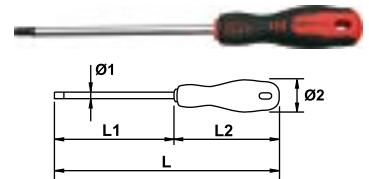

EGA**TAMPER TORX**

COD.		Ø 1 (mm)	Ø 2 (mm)	L (mm)	L1 (mm)	L2 (mm)			
65965	TT-6								
65966	TT-7	3		125	50				
65967	TT-8								
65968	TT-9		22			75	16		
65969	TT-10	4		150	75				
65972	TT-15								
65973	TT-20			175				I	
65974	TT-25	5		205	100				
65994	TT-27	6	31	220	115	105	8		
65995	TT-30			230					
65996	TT-40	7		240	125				
65997	TT-45	8	35	265	150	115	6		
65998	TT-50	10		290	175				



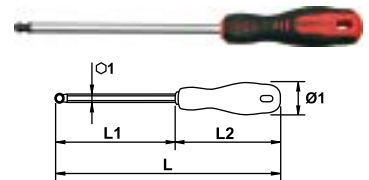

**PUNTA ESFERA / BALL TIP / TÊTE SPHÉRIQUE / KUGELKOPF / TESTA SFERICA / PONTA ESFERICA / С ШАРОВОЙ ГОЛОВКОЙ****MM**

COD.	HEX 1 (mm)	Ø 1 (mm)	L (mm)	L1 (mm)	L2 (mm)			
66928	2,5							●
66929	3	22	150	75	75	16		●
66930	4		175					●
66931	5		205	100			I	●
66932	6	31	230	125	105	8		●
66933	8	35	265	150	115	6		-
67090	10							-

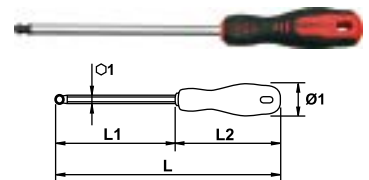
**INCH**

COD.	HEX 1 (inch)	Ø 1 (mm)	L (mm)	L1 (inch)	L2 (mm)			
55440	1/8							●
55441	5/32	22	150	3	75	16		●
55442	3/16		175	4				●
55443	1/4	31	205	5	105	8	I	●
55444	5/16		230	5				●
55445	25/64	35	268	6	115	6		●

**ROBERTSON**

COD.		AF $\frac{mm}{mm}$	Ø 1 (mm)	Ø 2 (mm)	L (mm)	L1 (mm)	L2 (mm)			
66934	1	2,4	5	22	175	100	75	16		●
66935	2	2,8		31	230	125	105	8	I	●
66936	3	3,4	6		255	150		6		●

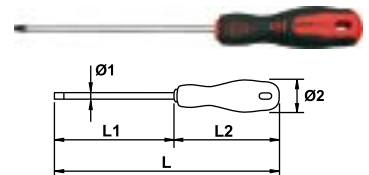

06

DESTORNILLADORES
SCREWDRIVERS
TOURNEVIS
SCHRAUBENZIEHER
CACCIAVITI
CHAVES DE FENDA
ОТВЕРТКИ

EGA

■ CARROCERO / STUBBY / TOM POUCE / SCHRAUBENDREHER, KURZE FORM / CACCIAVITI NANI / COTOS / КОРОТКАЯ

■ ELECTRICISTA / ELECTRICIAN / ELECTRICIEN / ELEKTRIK / PER ELETTRICISTI / ELETRECISTA / ЭЛЕКТРИЧЕСКАЯ

■ MM

COD.	A (mm)	B (mm)	Ø 1 (mm)	Ø 2 (mm)	L (mm)	L1 (mm)	L2 (mm)		
66937	5,5	1,2	5,5	31	85	25	60	20	I

 DIN 5265

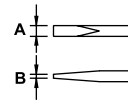
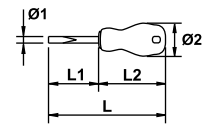



■ INCH

COD.	A (inch)	B (inch)	Ø 1 (mm)	Ø 2 (mm)	L (mm)	L1 (inch)	L2 (mm)		
55447	7/32	0,046	5,5	31	85	1	60	20	I

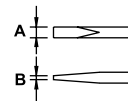
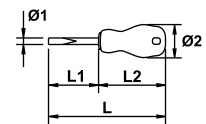
 DIN 5265





■ PHILIPS

COD.		Ø 1 (mm)	Ø 2 (mm)	L (mm)	L1 (mm)	L2 (mm)		
67190	PH-1	5	31	85	25	60	20	I
66938	PH-2	5,5	31	85	25	60	20	I

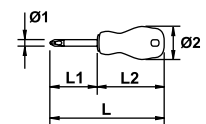
DIN 5262



■ POZIDRIV®*

COD.		Ø 1 (mm)	Ø 2 (mm)	L (mm)	L1 (mm)	L2 (mm)		
67191	PZ-1	5	31	85	25	60	20	I
66939	PZ-2	6	31	85	25	60	20	I

DIN 5262

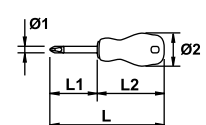

*Para tornillos POZIDRIV® (Marca registrada por European Ind. Serv. Ltd.) / *For screws POZIDRIV® (European Ind. Serv. Ltd. registered trademark) / *Pour vis POZIDRIV® (Marque enregistrée par European Ind. Serv. Ltd.)







06

DESTORNILLADORES
SCREWDRIVERS
TOURNEVIS
SCHRAUBENZIEHER
CACCIAVITI
CHAVES DE FENDA
ОТВЕРТКИ

EGA

■ **ACCESORIOS / ACCESSORIES / ACCESSOIRES / ERSATZTEILE / ACCESSORI / ACESSORIOS / ЗАПАСНЫЕ ЧАСТИ**

■ **PORTA-TORNILLOS MAGNÉTICOS / MAGNETIC SCREW HOLDERS / PORTE-TOURNEVIS MAGNÉTIQUE / MAGNETISCHER SCHRAUBENHALTER / PORTA INSERTI MAGNETICO / PORTA PARAFUSO MAGNÉTIC / МАГНИТНЫЙ ДЕРЖАТЕЛЬ ОТВЕРТКИ**

COD.	 O.D. mm	Válido para / Valid for / Valable pour	
66054	2-3	66420, 66421, 66422, 55354, 55354, 66438, 66456, 66474, 66475, 66476, 66477, 66478, 66488, 66489, 66490, 66491, 66501, 66502, 55364, 67149, 66886, 66887, 55428, 55429, 55430, 66897, 66907, 66917, 66918, 66919, 66928, 66929, 55440	
66052	4-5	66400, 66401, 66423, 66424, 66411, 66439, 66437, 66479, 66480, 66481, 66482, 76620, 76621, 76628, 76638, 76639, 76640, 76641, 76642, 66457, 66472, 66530, 66531, 66503, 66874, 66875, 66888, 66889, 66890, 66891, 76730, 76731, 76651, 66899, 66908, 67167, 76633, 66919, 66920, 66921, 66922, 66923, 66924, 66930, 66931, 66934, 66935	
66053	5,5-6	66425, 66412, 55358, 55359, 75063, 75064, 76622, 66444, 66483, 66458, 66473, 66532, 66892, 76652, 67053, 76655	
66049	* 5,5-6,15	66440, 66443, 76623, 76624, 76738, 76629, 76643, 76644, 66909, 66900, 66911, 66925, 66932, 66936, 76653, 76656, 76634	

*: Válido para puntas de 50 mm de longitud / Suitable for 50 mm length bits / Valable pour les pointes de 50 mm de longueur



Para trabajar con tornillos férricos
To work with ferrous screws
Pour travailler avec des vis ferriques



Para trabajar con tornillos inox
To work with stainless steel screws
Pour travailler avec des vis Inox



Válido para puntas de 50 mm de longitud
Suitable for 50 mm length bits
Valable pour les pointes de 50 mm de longueur



Aguanta hasta 2 kg de peso
Supports up to 2 kg weight
Supporte jusqu'à un poids de 2 Kg



Para ver las puntas disponibles consultar en el capítulo de puntas de destornillador del catálogo general o en www.egamaster.com

To see the available bits check the bits chapter of general catalog or in www.egamaster.com

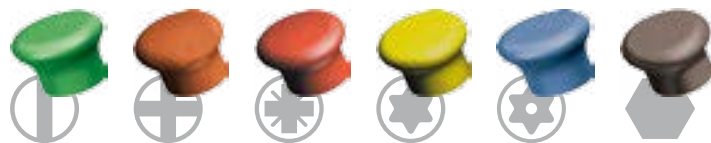

Pour voir les pointes disponibles merci de consulter le chapitre des pointes de tournevis du catalogue général ou sur www.egamaster.com

■ **MICROTRONIC**



■ **ELECTRICISTA / ELECTRICIAN / ELECTRICIEN / ELEKTRIK / PER ELETTRONICA / ELETRECISTA / ЭЛЕКТРИЧЕСКАЯ**

■ **MM**

COD.	A (mm)	B (mm)	Ø 1 (mm)	Ø 2 (mm)	L (mm)	L1 (mm)	L2 (mm)		
66846					145	50			
66847	2	0,4	3	21				10	I
66848	3	0,5			170	75	95		
66849	4	0,8	4						

 **DIN 6265**

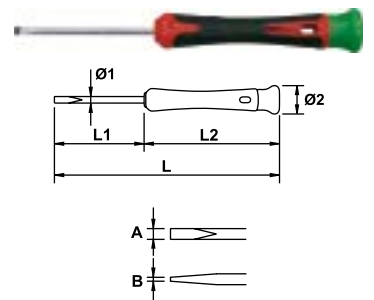



06

DESTORNILLADORES
SCREWDRIVERS
TOURNEVIS
SCHRAUBENZIEHER
CACCIAVITI
CHAVES DE FENDA
OTBEPTKИ

EGA



INCH

COD.	A (inch)	B (inch)	Ø 1 (mm)	Ø 2 (mm)	L (mm)	L1 (inch)	L2 (mm)		
55449	5/64	0,016	3	21	145	2	95	10	I
55450					170	3			
55451	1/8	0,02	4		170	3	95	10	I
55452	5/32	0,03							

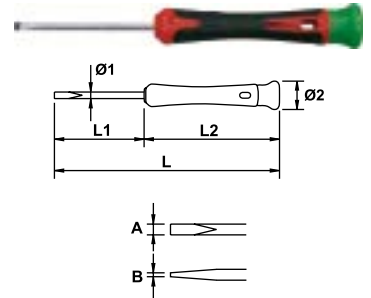
 | DIN 6265





1000V

COD.	A (mm)	B (mm)	Ø 1 (mm)	Ø 2 (mm)	Ø 3 (mm)	L (mm)	L1 (mm)	L2 (mm)		
75156	1,5	0,23	1,5	3,1	19	140	40	100	10	I
75157	1,8	0,3	1,8	3,4		160	60			
75158	2	0,4	2	3,6	19	175	75	100	10	I
75159	2,5		2,5	4,1						
75201	3	0,5	3	4,6						

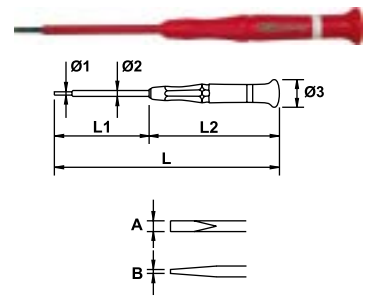
 | IEC 60900 | DIN 7437





PHILIPS

COD.		Ø 1 (mm)	Ø 2 (mm)	L (mm)	L1 (mm)	L2 (mm)		
66850	PH-00	2	21	145	50	95	10	I
66851	PH-0	3						
66852	PH-1	4		170	75			

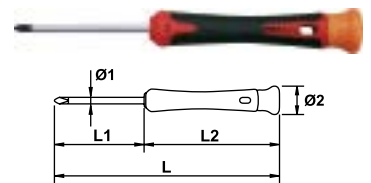
DIN 6262





1000V

COD.		Ø 1 (mm)	Ø 2 (mm)	Ø 3 (mm)	L (mm)	L1 (mm)	L2 (mm)		
75202	PH-00	2,5	4,1	19	175	75	100	10	I
75203	PH-0	3	4,6						

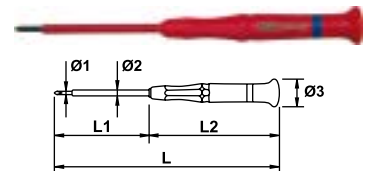
 | IEC 60900 | DIN 7438



POZIDRIV®*

COD.		Ø 1 (mm)	Ø 2 (mm)	L (mm)	L1 (mm)	L2 (mm)		
66853	PZ-0	3	21	145	50	95	10	I
66854	PZ-1	4		170	75			

DIN 6262

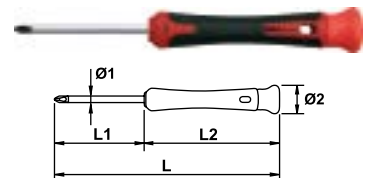



*Para tornillos POZIDRIV® (Marca registrada por European Ind. Serv. Ltd.) / *For screws POZIDRIV® (European Ind. Serv. Ltd. registered trademark) / *Pour vis POZIDRIV® (Marque enregistrée par European Ind. Serv. Ltd.)

06

DESTORNILLADORES
SCREWDRIVERS
TOURNEVIS
SCHRAUBENZIEHER
CACCIAVITI
CHAVES DE FENDA
ОТВЕРТКИ



EGA

TORX®*

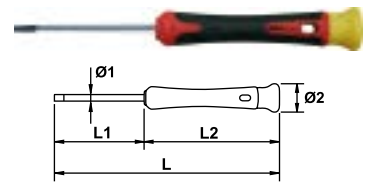
COD.		Ø 1 (mm)	Ø 2 (mm)	L (mm)	L1 (mm)	L2 (mm)		
66855	T-6	2						
66856	T-7			145	50			
66857	T-8							
66858	T-9	3	21			95	10	I
66859	T-10			170	75			
66860	T-15							
66861	T-20	4						



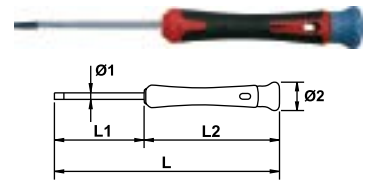

TAMPER TORX

COD.		Ø 1 (mm)	Ø 2 (mm)	L (mm)	L1 (mm)	L2 (mm)		
66866	TT-6	2						
66867	TT-7			145	50			
66868	TT-8							
66869	TT-9	3	21			95	10	I
66870	TT-10			170	75			
66871	TT-15							
66872	TT-20	4						





HEXAGONAL PUNTA ESFERA / HEXAGONAL BALL POINT / HEXAGONALE AVEC EMBOUT SPHÉRIQUE / HEXAGONAL KUGELKOPF / HEXAGONAL TESTA ESFERICA / HEXAGONAL COM PONTA ESFERICA / ШЕСТИГРАННИК С ШАРОВОЙ ГОЛОВКОЙ

MM

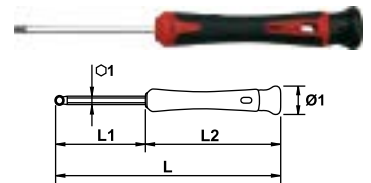
COD.		Ø 1 (mm)	L (mm)	L1 (mm)	L2 (mm)		
66862	1,5						
66863	2		145	50		10	I
66864	2,5	21			95		
66865	3		155	60			



INCH

COD.		Ø 1 (mm)	L (mm)	L1 (inch)	L2 (mm)		
55454	1/16						
55455	5/64	21	145	2	95	10	I
55457	1/8		155				

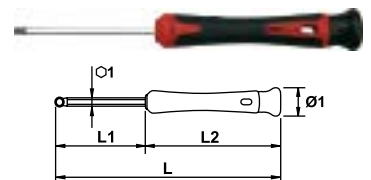

*Para tornillos TORX® (Marca registrada por Acument Intellectual Properties, LLC, Troy, Mich., US) / *For screws TORX® (Acument Intellectual Properties, LLC, Troy, Mich., US registered trademark) / *Pour vis TORX® (Marque enregistrée par Acument Intellectual Properties, LLC, Troy, Mich., US)

06

DESTORNILLADORES
SCREWDRIVERS
TOURNEVIS
SCHRAUBENZIEHER
CACCIAVITI
CHAVES DE FENDA
ОТВЕРТКИ

EGA

DESCARGA ELECTROSTÁTICA / ELECTROSTATIC DISCHARGE / DÉCHARGE ÉLECTROSTATIQUE / ELEKTROSTATISCHE ENTLADUNG / CACCIAVITI PER ELETTRONICA
STATICA / DESCARGA ELECTROSTÁTICA / РАЗРЯЖАТЕЛЬ СТАТИЧЕСКОГО ЭЛЕКТРИЧЕСТВА



ELECTRICISTA / ELECTRICIAN / ELECTRICIEN / ELEKTRIK / PER ELETTRONICA / ELETRECISTA / ЭЛЕКТРИЧЕСКАЯ

MM

COD.	A (mm)	B (mm)	Ø 1 (mm)	Ø 2 (mm)	L (mm)	L1 (mm)	L2 (mm)			
64740	1	0,2			140	40	14			
64741	1,5	0,3	2							
64742	2						16			
64743	2,5	0,4	2,5	16			17	10		
64744	3	0,5	3		160	60	19			
64745	3,5	0,6	3,5				21			I
64746	4	0,7	4				24			

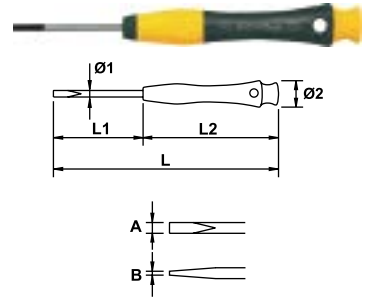

INCH

COD.	A (inch)	B (inch)	Ø 1 (mm)	Ø 2 (mm)	L (mm)	L1 (inch)	L2 (mm)			
55459		3/64			140		14			
55460	5/64	1/16	2							
55461		5/64					16			
55463	1/8	1/8	3	16		2	100	10		
55464	9/64	9/64	3,5		160		21			I
55465	5/32	5/32	4				24			

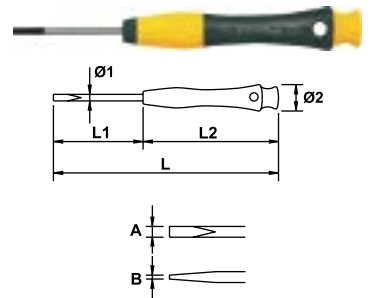

PHILIPS

COD.		Ø 1 (mm)	Ø 2 (mm)	L (mm)	L1 (mm)	L2 (mm)			
64747	PH00	2,5				17			
64748	PH0	3,0	16	160	60	100	19	10	
64749	PH1	4,0				24			I

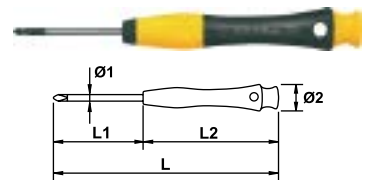

POZIDRIV®*

COD.		Ø 1 (mm)	Ø 2 (mm)	L (mm)	L1 (mm)	L2 (mm)			
64753	PZ0	3,0				19			
64754	PZ1	4,0	16	160	60	100	24	10	I

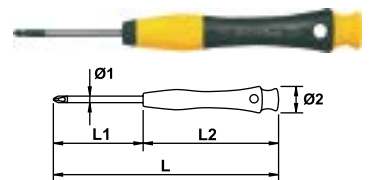

*Para tornillos POZIDRIV® (Marca registrada por European Ind. Serv. Ltd.) / *For screws POZIDRIV® (European Ind. Serv. Ltd. registered trademark) / *Pour vis POZIDRIV® (Marque enregistrée par European Ind. Serv. Ltd.)

06

DESTORNILLADORES
SCREWDRIVERS
TOURNEVIS
SCHRAUBENZIEHER
CACCIAVITI
CHAVES DE FENDA
ОТВЕРТКИ

EGA

TORX®*

COD.		Ø 1 (mm)	Ø 2 (mm)	L (mm)	L1 (mm)	L2 (mm)		
64756	T4							
64757	T5	2,5	16	140	40	100	14	10
64758	T6							

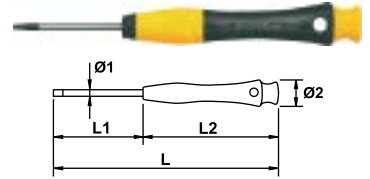

TAMPER TORX

COD.		Ø 1 (mm)	Ø 2 (mm)	L (mm)	L1 (mm)	L2 (mm)			
64762	TT-7	2,5		140	40	15			-
64763	TT-8		16					10	
64764	TT-9	3,0		160	60	19			I
64765	TT-10								

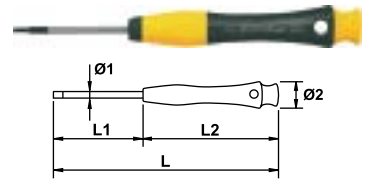

DESTORNILLADOR ACODADO / OFFSET SCREWDRIVER / TOURNEVIS CONTRE COUDÉ / WINKELSCHRAUBendreHER / CACCIAVITE A SQUADRA / CHAVE DE PARAFUSOS ANGULAR / КОЛЕНЧАТАЯ ОТВЕРТКА

NI

COD.	A	B	L (mm)	H (mm)			
57675	PH1	PH2	125	32	45		
57676	PH3	PH4	200	50	200		
57677	PZ1	PZ2	125	32	45		
57678	PZ3	PZ4	200	50	200		
57679	4	4 (90°)	100	25	25	10	I
57680	5,5	5,5 (90°)	125	30	45		
57681	6	6 (90°)					
57682	8	8 (90°)	150	40	100		
57683	10	10 (90°)	175	50	200		

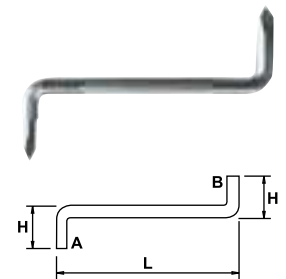

*Para tornillos TORX® (Marca registrada por Acument Intellectual Properties, LLC, Troy, Mich., US) / *For screws TORX® (Acument Intellectual Properties, LLC, Troy, Mich., US registered trademark) / *Pour vis TORX® (Marque enregistrée par Acument Intellectual Properties, LLC, Troy, Mich., US)

06

DESTORNILLADORES
SCREWDRIVERS
TOURNEVIS
SCHRAUBENZIEHER
CACCIAVITI
CHAVES DE FENDA
OTBEPTKИ

EGA

■ EXPOSITORES Y SETS / DISPLAYS AND SETS / PRESENTOIRS ET SETS / DISPLAY / ESPOSITORE / DISPLAY STAND / СТЕНДЫ

■ MASTERTORK

■ 1000V 4 PCS.



COD.	PCS.
74691	4

PCS.	COD.	PCS.
1	74665	10 mm
	74667	12 mm
	74669	14 mm
	74670	17 mm



COD.	PCS.	
76675	4	A
76676		B
76677		C

PCS.	COD.	PCS.	
1	76628	PH0	+
	76629	PH1	
	76630	PH2	
	76631	PH3	

COD.	PCS.	
76663	4	A
76664		B
76665		C

PCS.	COD.	PCS.	
1	76633	PZ0	+
	76634	PZ1	
	76635	PZ2	
	76636	PZ3	

■ 5 PCS.

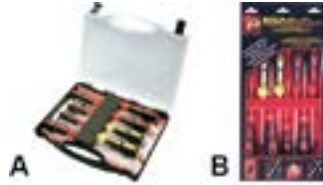

COD.	PCS.	
69909	5	A
69858		B
68487		C

PCS.	COD.	PCS.	
1	66422	3 x 100 mm	+
	66423	4 x 125 mm	
	66425	5,5 x 150 mm	
	66439	PH1	
	66440	PH2	

COD.	PCS.	
55506	5	A
55507		B
55508		C

PCS.	COD.	PCS.	
1	66420	2,5 x 75 mm	+
	66422	3 x 100 mm	
	66423	4 x 125 mm	
	66425	5,5 x 150 mm	
	66427	8 x 175 mm	

COD.	PCS.	
55510	5	B
55511		C

PCS.	COD.	PCS.	
1	66438	PH0	+
	66439	PH1	
	66440	PH2	
	66441	PH3	
	66442	PH4	

COD.	PCS.	
55513	5	B
55514		C

PCS.	COD.	PCS.	
1	66456	PZ0	+
	66457	PZ1	
	66458	PZ2	
	66459	PZ3	
	66460	PZ4	

■ 1000V 5 PCS.



COD.	PCS.	
76666	5	A
76667		B
76668		C

PCS.	COD.	PCS.	
1	76621	3 x 100 mm	+
	76622	4 x 125 mm	
	76624	5,5 x 150 mm	
	76625	6,5 x 150 mm	
	76626	8 x 175 mm	

COD.	PCS.	
76909	5	A
76910		B
76911		C

PCS.	COD.	PCS.	
1	76621	3 x 100 mm	+
	76622	4 x 125 mm	
	76624	5,5 x 150 mm	
	76634	PZ1	
	76635	PZ2	

COD.	PCS.	
76916	5	B
76917		C

PCS.	COD.	PCS.	
1	76628	PH0	+
	76629	PH1	
	76630	PH2	
	76631	PH3	
	76632	PH4	

06

DESTORNILLADORES
SCREWDRIVERS
TOURNEVIS
SCHRAUBENZIEHER
CACCIAVITI
CHAVES DE FENDA
OTBEPCKH

EGA

6 PCS.



COD.	PCS.	
69910	6	A
69859		B
68488		C

PCS.	COD.	PCS.	
1	66420	2,5 x 75 mm	
	66421	3 x 100 mm	
	66423	4 x 125 mm	
	66425	5,5 x 150 mm	
	66439	PH1	
	66440	PH2	-

COD.	PCS.	
55500	6	A
55501		B
55502		C

PCS.	COD.	PCS.	
1	66400	3 x 80 mm	
	66401	4 x 100 mm	
	66403	5,5 x 125 mm	
	66405	6,5 x 150 mm	
	66407	8 x 200 mm	
	66408	10 x 200 mm	-

COD.	PCS.	
55518	6	A
55519		B
55520		C

PCS.	COD.	PCS.	
1	66401	4 x 100 mm	
	66402	5,5 x 100 mm	
	66404	6,5 x 125 mm	
	66457	PZ1	
	66458	PZ2	
	66459	PZ3	-

COD.	PCS.	
55521	6	A
55522		B
55523		C

PCS.	COD.	PCS.	
1	66401	4 x 100 mm	
	66402	5,5 x 100 mm	

PCS.	COD.	PCS.	
1	66405	6,5 x 150 mm	
	66439	PH1	
	66440	PH2	
	66441	PH3	

1000V 6 PCS.



COD.	PCS.	
76669	6	A
76670		B
76671		C

PCS.	COD.	PCS.	
1	76620	2,5 x 75 mm	
	76621	3 x 100 mm	
	76622	4 x 125 mm	
	76624	5,5 x 150 mm	
	76625	6,5 x 150 mm	
	76626	8 x 175 mm	-

COD.	PCS.	
76900	6	A
76901		B
76902		C

PCS.	COD.	PCS.	
1	76621	3 x 100 mm	
	76622	4 x 125 mm	
	76624	5,5 x 150 mm	
	76628	PH0	
	76629	PH1	
	76630	PH2	-

COD.	PCS.	
76921	6	A
76922		B
76923		C

PCS.	COD.	PCS.	
1	76620	2,5 x 75 mm	
	76621	3 x 100 mm	
	76622	4 x 125 mm	
	76623	5,5 x 125 mm	
	76629	PH1	
	76630	PH2	-

COD.	PCS.	
76927	6	A
76928		B
76929		C

PCS.	COD.	PCS.	
1	76621	3 x 100 mm	
	76622	4 x 125 mm	
	76625	6,5 x 150 mm	
	76629	PH1	
	76630	PH2	
	76631	PH3	-

COD.	PCS.	
76933	6	A
76934		B
76935		C

PCS.	COD.	PCS.	
1	76621	3 x 100 mm	
	76622	4 x 125 mm	
	76625	6,5 x 150 mm	
	76633	PZ0	
	76634	PZ1	
	76635	PZ2	-

COD.	PCS.	
76930	6	A
76931		B
76932		C

PCS.	COD.	PCS.	
1	76640	T8	
	76641	T9	
	76642	T10	
	76643	T15	
	76644	T20	
	76645	T25	

COD.	PCS.	
76926	6	C

PCS.	COD.	PCS.	
1	74701	6 mm	
	74702	7 mm	
	74703	8 mm	
	74704	9 mm	
	74705	10 mm	
	74708	13 mm	

06

DESTORNILLADORES
SCREWDRIVERS
TOURNEVIS
SCHRAUBENZIEHER
CACCIAVITI
CHAVES DE FENDA
OTBEPTKM

EGA

■ 7 PCS.



COD.	PCS.	
55524		A
55525	7	B
55526		C

PCS.	COD.	PCS.	
1	66474	T6	
	66476	T8	
	66478	T10	
	66479	T15	
	66480	T20	
	66481	T25	
	66483	T30	

COD.	PCS.	
55527		A
55528	7	B
55529		C

PCS.	COD.	PCS.	
1	66478	T10	
	66479	T15	
	66480	T20	
	66481	T25	
	66482	T27	
	66483	T30	
	66484	T40	

■ 8 PCS.



COD.	PCS.	
69911		A
69860	8	B
68489		C

PCS.	COD.	PCS.			
1	66421	3 x 100 mm			
	66423	4 x 125 mm			
	66403	5,5 x 125 mm			
	66405	6,5 x 150 mm			
	66438	PH0			-
	66439	PH1			-
	66457	PZ1			-
	66458	PZ2			-

COD.	PCS.	
55503		A
55504	8	B
55505		C

PCS.	COD.	PCS.		
1	66400	3 x 80 mm		
	66401	4 x 100 mm		
	66402	5,5 x 100 mm		
	66403	5,5 x 125 mm		
	66404	6,5 x 125 mm		
	66406	8 x 150 mm		
	66407	8 x 200 mm		
	66408	10 x 200 mm		

COD.	PCS.	
55515		A
55516	8	B
55517		C

PCS.	COD.	PCS.			
1	66400	3 x 80 mm			
	66401	4 x 100 mm			
	66403	5,5 x 125 mm			
	66405	6,5 x 150 mm			
	66438	PH0			-
	66439	PH1			-
	66440	PH2			-
	66441	PH3			-

■ 1000V 8 PCS.



COD.	PCS.	
76672		A
76673	8	B
76674		C

PCS.	COD.	PCS.			
1	76621	3 x 100 mm			
	76622	4 x 125 mm			
	76624	5,5 x 150 mm			
	76625	6,5 x 150 mm			
	76629	PH1			-
	76630	PH2			-
	76634	PZ1			-
	76635	PZ2			-

COD.	PCS.	
76918		A
76919	8	B
76920		C

PCS.	COD.	PCS.			
1	76628	2,5 x 75 mm			
	76629	4 x 125 mm			
	76630	5,5 x 125 mm			
	76631	6,5 x 150 mm			
	76620	PH0			-
	76622	PH1			-
	76623	PH2			-
	76625	PH3			-

COD.	PCS.	
76939		A
76940	8	B
76941		C

PCS.	COD.	PCS.			
1	76620	2,5 x 75 mm			
	76621	3 x 100 mm			
	76622	4 x 125 mm			
	76625	6,5 x 150 mm			
	76628	PH0			-
	76629	PH1			-
	76630	PH2			-
	76631	PH3			-

COD.	PCS.	
76906		A
76907	8	B

■ 1000V 7 PCS.



COD.	PCS.	
76938	7	C

PCS.	COD.	PCS.	
1	74699	5 mm	
	74700	5,5 mm	
	74701	6 mm	
	74702	7 mm	
	74703	8 mm	
	74705	10 mm	
	74708	13 mm	

06

DESTORNILLADORES
SCREWDRIVERS
TOURNEVIS
SCHRAUBENZIEHER
CACCIAVITI
CHAVES DE FENDA
OTBEPTKM

EGA

COD.	PCS.	
76908	8	C

PCS.	COD.	PCS.		
1	76620	2,5 x 75 mm		
	76621	3 x 100 mm		
	76622	4 x 125 mm		
	76624	5,5 x 150 mm		
	76625	6,5 x 150 mm		
	76633	PZ0		-
	76634	PZ1		-
76635	PZ2	-		

COD.	PCS.	
76903		A
76904	8	B
76905		C

PCS.	COD.	PCS.	
1	76621	3 x 100 mm	
	76622	4 x 125 mm	
	76624	5,5 x 150 mm	
	76625	6,5 x 150 mm	
	76629	PH1	
76630	PH2	-	
76634	PZ1	-	
76635	PZ2	-	

COD.	PCS.	
76912		A
76913	8	B
76914		C

PCS.	COD.	PCS.	
1	76628	PH0	
	76629	PH1	
	76630	PH2	
	76631	PH3	
	76633	PZ0	
	76634	PZ1	
	76635	PZ2	
	76636	PZ3	

9 PCS.



COD.	PCS.	
55992	9	D

PCS.	COD.	PCS.	
1	55330	1/8" x 3"	
	55331	5/32" x 4"	
	55332	7/32" x 4"	
	55334	1/4" x 5"	
	55336	5/16" x 6"	
	55338	3/8" x 8"	

PCS.	COD.	PCS.	
1	55339	25/64" x 8"	
	55340	15/32" x 10"	
	55341	1/2" x 10"	

COD.	PCS.	
56029	9	D

PCS.	COD.	PCS.	
1	55373	5/32"	
	55374	3/16"	
	55375	7/32"	
	55376	1/4"	
	55378	5/16"	
	55379	11/32"	
	55380	25/64"	
	55382	15/32"	
	55383	1/2"	

10 PCS.

COD.	PCS.	
55991	10	D

PCS.	COD.	PCS.	
1	66400	3 x 80 mm	
	66401	4 x 100 mm	
	66402	5,5 x 100 mm	
	66404	6,5 x 125 mm	
	66406	8 x 150 mm	
	66407	8 x 200 mm	
	66408	10 x 200 mm	
	66409	12 x 250 mm	
	66449	13 x 250 mm	
	66410	14 x 250 mm	

1000V 10 PCS.

COD.	PCS.	
79468	10	D

PCS.	COD.	PCS.	
1	75132	5/32"	
	74984	3/16"	
	75133	7/32"	
	74985	1/4"	
	74986	5/16"	
	74987	3/8"	
	75136	25/64"	
	74988	7/16"	
	75138	15/32"	
	74989	1/2"	

12 PCS.

COD.	PCS.	
55996	12	D

PCS.	COD.	PCS.	
1	66488	TT7	
	66489	TT8	
	66490	TT9	
	66491	TT10	
	66492	TT15	
	66493	TT20	
	66494	TT25	

PCS.	COD.	PCS.	
1	66495	TT27	
	66496	TT30	
	66497	TT40	
	66498	TT45	
	66499	TT50	

COD.	PCS.	
55997	12	D

PCS.	COD.	PCS.	
1	66510	4 mm	
	66511	5 mm	
	66512	5,5 mm	
	66513	6 mm	
	66514	7 mm	
	66515	8 mm	
	66516	9 mm	
	66517	10 mm	
	66518	11 mm	
	66519	12 mm	
	66520	13 mm	
	66521	14 mm	

1000V 12 PCS.

COD.	PCS.	
79466	12	D

PCS.	COD.	PCS.	
1	75038	TT7	
	75039	TT8	
	75040	TT9	
	75041	TT10	
	75042	TT15	
	75043	TT20	
	75044	TT25	
	75045	TT27	
	75046	TT30	
	75047	TT40	
	75048	TT45	
	75049	TT50	

COD.	PCS.	
79467	12	D

PCS.	COD.	PCS.	
1	74698	4 mm	
	74699	5 mm	
	74700	5,5 mm	
	74701	6 mm	
	74702	7 mm	
	74703	8 mm	
	74704	9 mm	
	74705	10 mm	
	74706	11 mm	
	74707	12 mm	
	74708	13 mm	
	74709	14 mm	

13 PCS.

COD.	PCS.	
56028	13	D

06

DESTORNILLADORES
SCREWDRIVERS
TOURNEVIS
SCHRAUBENZIEHER
CACCIAVITI
CHAVES DE FENDA
OTBEPTKI

EGA

PCS.	COD.	PCS.
	66474	T6
	66475	T7
	66476	T8
	66477	T9
	66478	T10
	66479	T15
1	66480	T20
	66481	T25
	66482	T27
	66483	T30
	66484	T40
	66485	T45
	66486	T50



1000V 13 PCS.

COD.	PCS.
79465	13

D

PCS.	COD.	PCS.
	76638	T6
	76639	T7
	76640	T8
	76641	T9
	76642	T10
	76643	T15
1	76644	T20
	76645	T25
	76646	T27
	76647	T30
	76648	T40
	76649	T45
	76650	T50



150 PCS.



COD.	PCS.
66540	150

PCS.	COD.	PCS.
	66402	5,5 x 100 mm
	66404	6,5 x 125 mm
	66406	8 x 150 mm
	66421	3 x 60 mm
	66422	3 x 100 mm
10	66423	4 x 125 mm
	66425	5,5 x 150 mm
	66426	6,5 x 150 mm
	76621	3 x 100 mm
	66438	PH0



PCS.	COD.	PCS.
	66439	PH1
	66440	PH2
10	66456	PZ0
	66457	PZ1
	66458	PZ2



56 PCS.



COD.	PCS.
66541	56

PCS.	COD.	PCS.
6	66402	5,5 x 100 mm
5	66404	6,5 x 125 mm
	66406	8 x 150 mm
	66423	4 x 125 mm
	66425	5,5 x 150 mm
6	76622	4 x 125 mm
	66439	PH1
5	66440	PH2
6	66457	PZ1
5	66458	PZ2



T - MASTERTORK

6 PCS.



COD.	PCS.
55393	6

PCS.	COD.	PCS.
	55386	3/32"
	55387	1/8"
1	55388	5/32"
	55390	1/4"
	55391	5/16"
	55392	25/64"



7 PCS.

COD.	PCS.
55403	7

PCS.	COD.	PCS.
	66571	2,5 mm
	66572	3 mm
	66573	4 mm
1	66574	5 mm
	66575	6 mm
	66576	8 mm
	66577	10 mm



ROTORK

1000V 4 PCS.



COD.	PCS.
76987	4
76988	4
76989	4

A

B

C

PCS.	COD.	PCS.
	76655	PH0
1	76656	PH1
	76657	PH2
	76658	PH3



COD.	PCS.
76984	4
76985	4
76986	4

A

B

C

PCS.	COD.	PCS.
	76659	PZ0
1	76660	PZ1
	76661	PZ2
	76662	PZ3



06

DESTORNILLADORES
SCREWDRIVERS
TOURNEVIS
SCHRAUBENZIEHER
CACCIAVITI
CHAVES DE FENDA
OTBEPCKH

EGA

5 PCS.



COD.	PCS.	
69912	5	A
66995		B
68495		C

PCS.	COD.	PCS.	
1	66877	5,5 x 125 mm	
	66887	3 x 100 mm	
	66890	5 x 150 mm	
	66898	PH1	
	66899	PH2	

COD.	PCS.	
69109	5	A
69125		B
69126		C

PCS.	COD.	PCS.	
1	66874	3 x 80 mm	
	66875	4 x 100 mm	
	66877	5,5 x 125 mm	
	66879	6,5 x 150 mm	
	66881	8 x 200 mm	

COD.	PCS.	
69142	5	A
69143		B
69144		C

PCS.	COD.	PCS.	
1	66886	3 x 60 mm	
	66887	3 x 100 mm	
	66888	4 x 125 mm	
	66890	5 x 150 mm	
	66891	5 x 200 mm	

COD.	PCS.	
69714	5	B
69718		C

PCS.	COD.	PCS.	
1	66897	PH0	
	66898	PH1	
	66899	PH2	
	66900	PH3	
	67131	PH4	

COD.	PCS.	
69723	5	B
69727		C

PCS.	COD.	PCS.	
1	66907	PZ0	
	66908	PZ1	
	66909	PZ2	
	66910	PZ3	
	67064	PZ4	

COD.	PCS.	
55536	5	A
55537		B
55538		C

PCS.	COD.	PCS.	
1	67149	2,5 x 60 mm	
	66887	3 x 100 mm	
	66888	4 x 125 mm	
	66890	5 x 150 mm	
	67108	8 x 175 mm	

COD.	PCS.	
55543	5	B
55544		C

PCS.	COD.	PCS.	
1	66897	PH0	
	66898	PH1	
	66899	PH2	
	66900	PH3	
	67131	PH4	

COD.	PCS.	
55546	5	B
55547		C

PCS.	COD.	PCS.	
1	66907	PZ0	
	66908	PZ1	
	66909	PZ2	
	66910	PZ3	
	67064	PZ4	

1000V 5 PCS.



COD.	PCS.	
76961	5	B
76962		C

PCS.	COD.	PCS.	
1	76655	PH0	
	76656	PH1	
	76657	PH2	
	76658	PH3	
	76735	PH4	

6 PCS.



COD.	PCS.	
69913	6	A
66996		B
68496		C

PCS.	COD.	PCS.	
1	67149	2,5 x 60 mm	
	66887	3 x 100 mm	
	66888	4 x 125 mm	
	66890	5 x 150 mm	
	66898	PH1	
	66899	PH2	

COD.	PCS.	
55530	6	A
55531		B
55532		C

PCS.	COD.	PCS.	
1	66874	3 x 80 mm	
	66875	4 x 100 mm	
	66877	5,5 x 125 mm	
	66879	6,5 x 150 mm	
	66881	8 x 200 mm	
	66882	10 x 200 mm	

COD.	PCS.	
55551	6	A
55552		B
55553		C

PCS.	COD.	PCS.	
1	66875	4 x 100 mm	
	66877	5,5 x 125 mm	
	66879	6,5 x 150 mm	
	66898	PH1	
	66899	PH2	
	66900	PH3	

COD.	PCS.	
55548	6	A
55549		B

06

DESTORNILLADORES
SCREWDRIVERS
TOURNEVIS
SCHRAUBENZIEHER
CACCIAVITI
CHAVES DE FENDA
OTBEPTKH

EGA

COD.	PCS.	
55550	6	C

PCS.	COD.	PCS.	
1	66875	4 x 100 mm	
	66876	5,5 x 100 mm	
	66878	6,5 x 125 mm	
	66908	PZ1	-
	66909	PZ2	
	66910	PZ3	-

■ 1000V 6 PCS.



COD.	PCS.	
76680		A
76681	6	B
76682		C

PCS.	COD.	PCS.	
1	76651	3 x 100 mm	
	76652	4 x 125 mm	
	76653	5,5 x 150 mm	
	76655	PH0	-
	76656	PH1	
	76657	PH2	-

COD.	PCS.	
76972		A
76973	6	B
76974		C

PCS.	COD.	PCS.	
1	76730	2,5 x 60 mm	
	76651	3 x 100 mm	
	76652	4 x 125 mm	
	76653	5,5 x 150 mm	
	76654	6,5 x 150 mm	
	76732	8 x 175 mm	

COD.	PCS.	
76954		A
76955	6	B
76956		C

PCS.	COD.	PCS.	
1	76651	3 x 100 mm	
	76652	4 x 125 mm	
	76653	5,5 x 150 mm	
	76654	6,5 x 150 mm	
	76732	8 x 175 mm	
	76733	10 x 200 mm	

COD.	PCS.	
76966		A
76967	6	B
76968		C

PCS.	COD.	PCS.	
1	76730	2,5 x 60 mm	
	76651	3 x 100 mm	
	76652	4 x 125 mm	
	76653	5,5 x 150 mm	
	76656	PH1	
	76657	PH2	-

COD.	PCS.	
76942		A
76943	6	B
76944		C

PCS.	COD.	PCS.	
1	76651	3 x 100 mm	
	76652	4 x 125 mm	
	76653	5,5 x 150 mm	
	76655	PH0	-
	76656	PH1	
	76657	PH2	-

COD.	PCS.	
76951		A
76952	6	B
76953		C

PCS.	COD.	PCS.	
1	76651	3 x 100 mm	
	76652	4 x 125 mm	
	76653	5,5 x 150 mm	
	76659	PZ0	-
	76660	PZ1	
	76661	PZ2	-

COD.	PCS.	
76975		A
76976	6	B
76977		C

PCS.	COD.	PCS.	
1	76651	3 x 100 mm	
	76652	4 x 125 mm	
	76654	6,5 x 150 mm	
	76656	PH1	-
	76657	PH2	
	76658	PH3	-

COD.	PCS.	
76969		A
76970	6	B
76971		C

PCS.	COD.	PCS.	
1	76651	3 x 100 mm	
	76652	4 x 125 mm	
	76654	6,5 x 150 mm	
	76659	PZ0	

PCS.	COD.	PCS.	
1	76660	PZ1	
	76661	PZ2	-

■ 7 PCS.



COD.	PCS.	
55554		A
55555	7	B
55556		C

PCS.	COD.	PCS.	
1	66921	T10	
	66922	T15	
	66923	T20	
	66924	T25	
	66925	T27	
	66926	T30	
	66927	T40	

COD.	PCS.	
55557		A
55558	7	B
55559		C

PCS.	COD.	PCS.	
1	66917	T6	
	66919	T8	
	66921	T10	
	66922	T15	
	66923	T20	
	66924	T25	
	66926	T30	

■ 8 PCS.



COD.	PCS.	
69914		A
66997	8	B
68497		C

PCS.	COD.	PCS.	
1	66887	3 x 100 mm	
	66888	4 x 125 mm	
	66877	5,5 x 125 mm	
	66879	6,5 x 150 mm	
	66897	PH0	-
	66898	PH1	



06

DESTORNILLADORES
SCREWDRIVERS
TOURNEVIS
SCHRAUBENZIEHER
CACCIAVITI
CHAVES DE FENDA
OTBEPCKH



EGA

PCS.	COD.	PCS.		
1	66908	PZ1		-
	66909	PZ2		-



COD.	PCS.		
69127			A
69128	8		B
69129			C

PCS.	COD.	PCS.		
1	66874	3 x 80 mm		
	66875	4 x 100 mm		
	66876	5,5 x 100 mm		
	66877	5,5 x 125 mm		
	66878	6,5 x 125 mm		
	66880	8 x 150 mm		
	66881	8 x 200 mm		
	66882	10 x 200 mm		

COD.	PCS.		
69158			A
69159	8		B
69168			C

PCS.	COD.	PCS.		
1	67149	2,5 x 60 mm		
	66887	3 x 100 mm		
	66888	4 x 125 mm		
	66890	5 x 150 mm		
	66891	5 x 200 mm		
	66892	6 x 100 mm		
	67108	8 x 175 mm		
	67109	10 x 200 mm		





COD.	PCS.		
55560			A
55561	8		B
55562			C

PCS.	COD.	PCS.		
1	66874	3 x 80 mm		
	66875	4 x 100 mm		
	66877	5,5 x 125 mm		
	66879	6,5 x 150 mm		
	66897	PH0		-
	66898	PH1		-
	66899	PH2		-
	66900	PH3		-



1000V 8 PCS.





COD.	PCS.		
76683			A
76684	8		B
76685			C

PCS.	COD.	PCS.		
1	76651	3 x 100 mm		
	76652	4 x 125 mm		
	76653	5,5 x 150 mm		
	76654	6,5 x 150 mm		
	76656	PH1		-
	76657	PH2		-
	76660	PZ1		-
	76661	PZ2		-

COD.	PCS.		
76963			A
76964	8		B
76965			C



PCS.	COD.	PCS.		
1	76730	2,5 x 60 mm		
	76652	4 x 125 mm		
	76653	5,5 x 150 mm		
	76654	6,5 x 150 mm		
	76655	PH0		-
	76656	PH1		-
	76657	PH2		-
	76658	PH3		-

COD.	PCS.		
76981			A
76982	8		B
76983			C





PCS.	COD.	PCS.		
1	76730	2,5 x 60 mm		
	76651	3 x 100 mm		
	76652	4 x 125 mm		
	76654	6,5 x 150 mm		-
	76655	PH0		-
	76656	PH1		-
	76657	PH2		-
	76658	PH3		-

COD.	PCS.		
76948			A
76949	8		B



COD.	PCS.		
76950	8		C

PCS.	COD.	PCS.		
1	76730	2,5 x 60 mm		
	76731	3 x 60 mm		
	76652	4 x 125 mm		
	76653	5,5 x 150 mm		
	76654	6,5 x 150 mm		
	76659	PZ0		-
	76660	PZ1		-
	76661	PZ2		-

COD.	PCS.		
76978			A
76979	8		B
76980			C

PCS.	COD.	PCS.		
1	76651	3 x 100 mm		
	76652	4 x 125 mm		
	76653	5,5 x 150 mm		
	76654	6,5 x 150 mm		
	76655	PH0		-
	76656	PH1		-
	76657	PH2		-
	76658	PH3		-



COD.	PCS.		
76957			A
76958	8		B
76959			C

PCS.	COD.	PCS.		
1	76655	PH0		
	76656	PH1		
	76657	PH2		
	76658	PH3		
	76659	PZ0		
	76660	PZ1		
	76661	PZ2		
	76662	PZ3		

150 PCS.







COD.	PCS.
66992	150

PCS.	COD.	PCS.		
10	66876	5,5 x 100 mm		
	66878	6,5 x 125 mm		
	66880	8 x 150 mm		
	66886	3 x 60 mm		
	66887	3 x 100 mm		
	66888	4 x 125 mm		
	66890	5 x 150 mm		

06

DESTORNILLADORES
SCREWDRIVERS
TOURNEVIS
SCHRAUBENZIEHER
CACCIAVITI
CHAVES DE FENDA
OTBEPTKИ







EGA

PCS.	COD.	PCS.	
	66892	6 x 150 mm	
	76651	3 x 100 mm	
10	66897	PH0	
	66898	PH1	
	66899	PH2	
	66907	PZ0	
	66908	PZ1	
	66909	PZ2	

60 PCS.



COD.	PCS.
66993	60



PCS.	COD.	PCS.	
6	66876	5,5 x 100 mm	
5	66878	6,5 x 125 mm	
	66880	8 x 150 mm	
7	66887	3 x 100 mm	
	66888	4 x 125 mm	
	66890	5 x 150 mm	
	66898	PH1	
6	66899	PH2	
	66908	PZ1	
	66909	PZ2	



MICROTRONIC

100 PCS.









COD.	PCS.
66994	100

PCS.	COD.	PCS.	
	66846	2 x 50 mm	
	66847	2 x 75 mm	
5	66848	3 x 75 mm	
	66849	4 x 75 mm	
	66850	PH00	
	66851	PH0	
	66852	PH1	
	66853	PZ0	

PCS.	COD.	PCS.	
	66854	PZ1	
	66855	T6	
	66856	T7	
5	66857	T8	
	66858	T9	
	66859	T10	
	66860	T15	
	66861	T20	
	66862	1,5 x 50 mm	
	66863	2 x 50 mm	
	66864	2,5 x 50 mm	
	66865	3 x 60 mm	



COD.	PCS.
66990	100



PCS.	COD.	PCS.	
	66846	2 x 50 mm	
	66847	2 x 75 mm	
	66848	3 x 75 mm	
	66849	4 x 75 mm	
	66850	PH00	
	66851	PH0	
	66852	PH1	
5	66853	PZ0	
	66854	PZ1	
	66866	TT6	
	66867	TT7	
	66868	TT8	
	66869	TT9	
	66870	TT10	
	66871	TT15	
	66872	TT20	
	66862	1,5 x 50 mm	
	66863	2 x 50 mm	
	66864	2,5 x 50 mm	
	66865	3 x 60 mm	

6 PCS.



COD.	PCS.
66999	6



PCS.	COD.	PCS.	
1	66846	2 x 50 mm	

PCS.	COD.	PCS.	
	66848	3 x 75 mm	
	66850	PH00	
1	66851	PH0	
	66853	PZ0	
	66854	PZ1	

1000V 7 PCS.



COD.	PCS.
76083	7



PCS.	COD.	PCS.	
	75156	1,5 x 40 mm	
	75157	1,8 x 60 mm	
1	75158	2 x 60 mm	
	75159	2,5 x 75 mm	
	75201	3 x 75 mm	
	75202	PH00	
	75203	PH0	

8 PCS.



COD.	PCS.
69496	8

Cromado negro / Black chrome plating / Chromee noir

PCS.	COD.	PCS.	Descripción / Description / Description	
	69530		Pinza / Tweezers	-
	62526			125 mm
1	62527		Minis para electrónica / Electronic pliers	-
	62528			150 mm
	62529			115 mm
	62531			110 mm
	66846		Destornilladores Microtronic / Microtronic screwdrivers	2 x 50 mm 
	66850			PH00 

06

DESTORNILLADORES
SCREWDRIVERS
TOURNEVIS
SCHRAUBENZIEHER
CACCIAVITI
CHAVES DE FENDA
ОТВЕРТКИ

EGA

■ ESD

■ 8 PCS.



COD.	PCS.
68898	8



PCS.	COD. PCS.	Descripción / Description / Description		
1	64730	Alicate universal Mini ESD / ESD Mini Combination plier	115 mm	
	64736	Alicate corte diagonal Mini ESD / ESD Mini Diagonal cutting plier		-
	64733	Alicate telefonista Mini ESD / ESD Mini Long nose plier	135 mm	
	64742	Destornilladores Mini ESD / ESD Mini Screwdrivers	2 x 60 mm	
	64744		3 x 60 mm	
	64747		PH00	
	64748		PH0	
	64749		PH1	

■ 6 PCS.



COD.	PCS.
68899	6

PCS.	COD. PCS.		
1	64747	PH00	
	64748	PH0	
	64742	2 x 60 mm	
	64744	3 x 60 mm	
	64753	PZ0	
	64754	PZ1	

■ **BUSCAPOLOS / VOLTAGE TESTER / TESTEUR / SPANNUNGSPRÜFER / CERCAFASE / BUSCA-POLOS / ИЗМЕРИТЕЛЬ НАПРЯЖЕНИЯ**

■ **BUSCAPOLOS / VOLTAGE TESTER / TESTEUR / SPANNUNGSPRÜFER / CERCAFASE / BUSCA-POLOS / ИЗМЕРИТЕЛЬ НАПРЯЖЕНИЯ**

COD.	L (mm)		V			
66072	150			20	12	I
66073	190	3 x 15	100-250 AC	30		



■ **BUSCAPOLOS DIGITAL / DIGITAL VOLTAGE TESTER / TESTEUR DIGITAL / DIGITAL SPANNUNGSPRÜFER / CERCAFASE DIGITALE / BUSCA-POLOS DIGITAL / ЦИФРОВОЙ ИЗМЕРИТЕЛЬ НАПРЯЖЕНИЯ**

COD.	L (mm)		V			
66074	160	3 x 15	0-220 AC/DC	40	4	I



CARACTERÍSTICAS / FEATURES / CARACTÉRISTIQUES

5 niveles de tensión / 5 voltage levels / 5 niveaux de tension

■ **TESTER ELECTRÓNICO MEDIDOR DE TENSIÓN 2 EN 1 / ELECTRONIC TESTER 2 IN 1 / TESTEUR ELECTRONIQUE À MESURE DE TENSION 2 EN 1 / SPANNUNGSPRÜFER ELEKTRONIK, 2 IN 1 / TESTER ELECTRONICO 2 IN 1 / MEDIDOR DE TENSÃO 2 EM 1 / ЭЛЕКТРОННЫЙ ТЕСТЕР 2 В 1**

COD.	L (mm)	V			
66075	190	6-380 AC	220	4	I







06

DESTORNILLADORES
SCREWDRIVERS
TOURNEVIS
SCHRAUBENZIEHER
CACCIAVITI
CHAVES DE FENDA
ОТВЕРТКИ

EGA

BUSCAPOLOS CLASSIC / VOLTAGE TESTER / TESTEUR / SPANNUNGSPRÜFER / CERCAFASE / BUSCA-POLOS / ИЗМЕРИТЕЛЬ НАПРЯЖЕНИЯ

CLASSIC

COD.	L (mm)			V			
66070	140	65	3	100-250 AC	20		
66071	190	100	4		35	12	I
66069			3,5	90-480 AC	40		





MAGNETIZADOR-DESMAGNETIZADOR / MAGNETIZER-DEMAGNETIZER / MAGNETISEUR-DEMAGNETISEUR / MAGNETISIERT-ENTMAGNETISIERVORRICHTUNG / MAGNETIZZATORE-SMAGNETIZZATORE / MAGNETIZADOR-DESMAGNETIZADOR / НАМАГНИЧИВАТЕЛЬ-РАЗМАГНИЧИВАТЕЛЬ

COD.			
69504	80	12	I

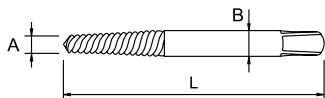

EXTRACTORES DE TORNILLOS / SCREW STRACTORS / EXTRACTEUR DE VIS / SCHRAUBENAUSDREHER / ESTRATTORI / EXTRACTORES DE PERNOS / РЕЗЬБОВЫЕ ЭКСТРАКТОРЫ



COD.	L (mm)	A (mm)	B (mm)	M	D (mm)	
61583	50	2,6	3,9	3-6	2,5	5
61584	55	3,0	4,3	6-8	3,0	10
61585	65	4,0	6,5	8-11	4,5	20
61586	75	4,5	7,5	11-14	6,0	30
61587	85	7,0	11	14-18	8,0	50
61588	90	9,0	15	18-25	11	100
61589	95	9,5	19	25-35	14	150
61590	100	14	24	>35	20	200

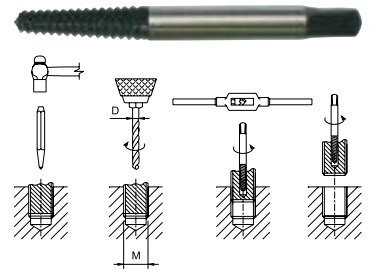

SET

COD.	PCS.	
61591	5	100
61592	6	200
61593	8	750

Composición / Composition / Composition

61583, 61584, 61585, 61586, 61587, 61588, 61589, 61590

