

14

LIMAS, ESCOFINAS, BOTADORES Y GRANETES

FILES, RASPS & PUNCHES

LIMES, RAPES, POINTEAUX ET CHASSES GOUPILLES

FEILEN, RASPELN, DURCHSCHLÄGER UND KÖRNER

LIMA, RASPE E PUNZONI

LIMAS, GROSAS E PUNÇÕES

НАПИЛЬНИКИ, РАШПИЛИ, МЕТЧИКИ



14

LIMAS Y ESCOFINAS

FILES & RASPS

LIMES ET RAPES

La gama completa de limas y escofinas super-profesionales EGA Master ofrece soluciones a todas las necesidades de acabado.

EGA Master super-professional file and rasp range offers solutions to all finishing needs.

La gamme complète de limes et de râpes super professionnelles EGA Master donne une solution à tous les problèmes.

		Debaste <i>Roughing</i> Bâtarde	Limado medio <i>Medium filing</i> Demi-douce	Afilado o limado fino <i>Sharpening or smooth filing</i> Douce
Picado sencillo <i>Single cut</i> Une taille			■	■
Picado doble <i>Double cut</i> Doble coupe	Basto <i>Bastard</i> Bâtard	■	●	
	Entrefino <i>Medium</i> Demi douce		■	●
	Fino <i>Smooth</i> Douce		■	■
Escofina <i>Rasp</i> Râpe		■		

● Aceptable / *Acceptable* / Acceptable ■ Adecuado / *Appropriate* / Idéal



1

Acero alto en cromo y carbono.
High chrome and carbon steel.
Acier en haute teneur en chrome et carbone.

2

Templados hasta los 65 HRC.
Tempered up to 65HRC.
Trempe jusqu'à 65HRC.

3

Mango Bi-componente ergonómico y antideslizante BIMAT® de gran atractivo.
Highly attractive BIMAT® ergonomic and anti-slippery handle.
Manche bi-matière, ergonomique et anti-dérapant très attrayant.

4

Protección antioxidante.
Rust-proof treatment.
Protection anti-oxydation.

		Fundición <i>Casting</i> Fonte	Acero sin templar <i>Non Templed alloy</i> Acier	Acero de alta aleación <i>High Alloy steel</i> Alliage d'acier	Latón bronce <i>Brass Bronze</i> Laiton bronze	Aluminio <i>Aluminium</i> Aluminium	Madera, Plásticos... <i>Wood, plastic...</i> Bois, plastique...
Picado sencillo <i>Single cut</i> Une taille			■	■			
Picado doble <i>Double cut</i> Doble coupe	Basto <i>Bastard</i> Bâtard	■	■	●	■	■	●
	Entrefino <i>Medium</i> Demi douce	■	■	■	■	■	
	Fino <i>Smooth</i> Douce	●	■	■	●		
Escofina <i>Rasp</i> Râpe							■



● Aceptable / *Acceptable* / Acceptable ■ Adecuado / *Appropriate* / Idéal

14

LIMAS, ESCOFINAS, BOTADORES Y GRANETES
FILES, RASPS & PUNCHES
LIMES, RAPES, POINTEAUX ET CHASSES GOUPILLES
FEILEN, RASPELN, DURCHSCHLÄGER UND KÖRNER
LIMA, RASPE E PUNZONI
LIMAS, GROSAS E PUNÇÕES
НАПИЛЬНИКИ, РАШПИЛИ, МЕТЧИКИ

STANDARD

LIMAS PLANAS PARALELAS / HAND FILES / LIMES PLATES PARALLELES / FLACHSTUMPF / LIMA PIATTA PARALLELA / LIMAS PARALELAS / РУЧНЫЕ НАПИЛЬНИКИ

COD.	L (inch)	W/cm			A (mm)	B (mm)		
63491	4	1	14	85	12	2,5	45	
63492		2	22					
63493		3	28					
63494	6	1	11	114	16	4,0	90	5
63495		2	18					
63496		3	22					
63497	8	1	10	135	20	5,0	200	
63498		2	16					
63499		3	20					
63500	10	1	9	135	35	6,0	310	
63501		2	12					
63502		3	18					
63503	12	1	8	135	30	6,5	410	
63504		2	11					
63505		3	16					
63506	14	1	7	135	35	7,5	650	
63507		2	10					
63508		3	14					

1 : Basta / Bastard / Bâtarde
 2 : Entrefina / Medium / Demi-douce
 3 : Fina / Smooth / Douce

ISO 234/1 - ISO 234/2



ESPECIFICACIONES TÉCNICAS / TECHNICAL SPECIFICATION / DÉTAILS TECHNIQUES

Tolerancia en corte según la norma / Cutting tolerance according to / Tolérance de coupe conforme à la norme ISO 234/2 (+/- 8%)

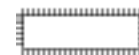
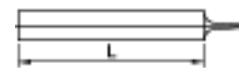
Ángulo de corte según la norma / Angle cut according to / Angle de coupe conforme à la norme ISO 234/2 (65° +/- 5%)



LIMAS PLANAS DE PUNTA / FLAT FILES / LIMES PLATES DE BOUT / FLACHSPITZ / LIMA PIATTA A PUNTA / LIMAS CHATAS / ПЛОСКИЕ НАПИЛЬНИКИ

COD.	L (inch)	W/cm			A (mm)	B (mm)		
63527	4	1	14	85	12	2,5	40	
63528		2	22					
63529		3	28					
63530	6	1	11	114	16	4,0	80	5
63531		2	18					
63532		3	22					
63533	8	1	10	135	20	5,0	180	
63534		2	16					
63535		3	20					
63536	10	1	9	135	35	6,0	270	
63537		2	12					
63538		3	18					
63539	12	1	8	135	30	6,5	370	
63540		2	11					
63541		3	16					
63542	14	1	7	135	35	7,5	600	
63543		2	10					
63544		3	14					

1 : Basta / Bastard / Bâtarde
 2 : Entrefina / Medium / Demi-douce
 3 : Fina / Smooth / Douce

ISO 234/1 - ISO 234/2

ESPECIFICACIONES TÉCNICAS / TECHNICAL SPECIFICATION / DÉTAILS TECHNIQUES

Tolerancia en corte según la norma / Cutting tolerance according to / Tolérance de coupe conforme à la norme ISO 234/2 (+/- 8%)



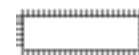





Ángulo de corte según la norma / Angle cut according to / Angle de coupe conforme à la norme ISO 234/2 (65° +/- 5%)



14

LIMAS, ESCOFINAS, BOTADORES Y GRANETES
FILES, RASPS & PUNCHES
LIMES, RAPES, POINTEAUX ET CHASSES GOUPILLES
FEILEN, RASPELN, DURCHSCHLÄGER UND KÖRNER
LIMA, RASPE E PUNZONI
LIMAS, GROSAS E PUNÇÕES
НАПИЛЬНИКИ, РАШПИЛИ, МЕТЧИКИ

■ **LIMAS MEDIA CAÑA / HALF ROUND FILES / LIMES DEMI-RONDES / HALBRUND-FEILEN, SPITZE FORM / LIMA MEZZATONDA / LIMAS MEIA CANA / ПОЛУКРУГЛЫЕ НАПИЛЬНИКИ**

COD.	L (inch)	M/cm			A (mm)	B (mm)		
63563	4	1	14	85	10,5	3,0	24	
63564		2	22					
63565		3	28					
63566	6	1	11	114	16	4,5	70	
63567		2	18					
63568		3	22					
63569	8	1	10	135	20	6,0	150	
63570		2	16					
63571		3	20					
63572	10	1	9	135	25	7,0	260	
63573		2	12					
63574		3	18					
63575	12	1	8	135	30	8,5	370	
63576		2	11					
63577		3	16					
63578	14	1	7,0	135	35	10	650	
63579		2	10					
63580		3	14					

1: Basta /Bastard / Bâtarde
 2: Entrefina /Medium / Demi-douce
 3: Fina /Smooth / Douce







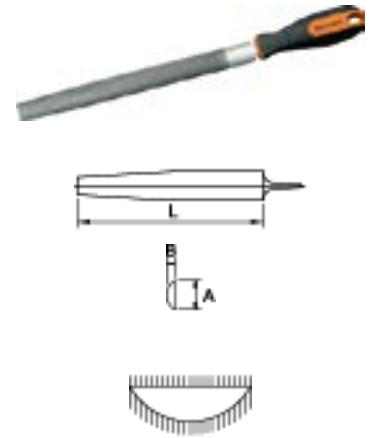

ISO 234/1 - ISO 234/2

ESPECIFICACIONES TÉCNICAS / TECHNICAL SPECIFICATION / DÉTAILS TECHNIQUES

Tolerancia en corte según la norma / Cutting tolerance according to / Tolérance de coupe conforme à la norme	ISO 234/2 (+/- 8%)
Ángulo de corte según la norma / Angle cut according to / Angle de coupe conforme à la norme	ISO 234/2 (65° +/- 5%)



■ **LIMAS TRIANGULARES / TRIANGULAR FILES / LIMES TRIANGULAIRES / DREIKANTFEILEN / LIMA TRIANGOLARE / LIMATÕES TRIANGULARES / ТРЕУГОЛЬНЫЕ НАПИЛЬНИКИ**

COD.	L (inch)	M/cm			A (mm)		
63599	4	1	14	85	8,0	27	
63600		2	22				
63601		3	28				
63602	6	1	11	114	11	70	
63603		2	18				
63604		3	22				
63605	8	1	10	135	15	150	
63606		2	16				
63607		3	20				
63608	10	1	9	135	17	205	
63609		2	12				
63610		3	18				
63611	12	1	8,0	135	20	340	
63612		2	11				
63613		3	16				
63614	14	1	7	135	24	600	
63615		2	10				
63616		3	14				

1: Basta /Bastard / Bâtarde
 2: Entrefina /Medium / Demi-douce
 3: Fina /Smooth / Douce

ISO 234/1 - ISO 234/2

ESPECIFICACIONES TÉCNICAS / TECHNICAL SPECIFICATION / DÉTAILS TECHNIQUES

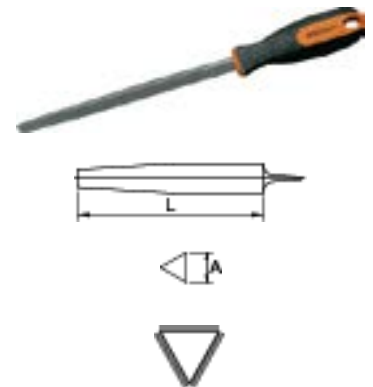

Tolerancia en corte según la norma / Cutting tolerance according to / Tolérance de coupe conforme à la norme	ISO 234/2 (+/- 8%)
Ángulo de corte según la norma / Angle cut according to / Angle de coupe conforme à la norme	ISO 234/2 (65° +/- 5%)



14

LIMAS, ESCOFINAS, BOTADORES Y GRANETES
FILES, RASPS & PUNCHES
LIMES, RAPES, POINTEAUX ET CHASSES GOUPILLES
FEILEN, RASPELN, DURCHSCHLÄGER UND KÖRNER
LIMA, RASPE E PUNZONI
LIMAS, GROSAS E PUNÇÕES
НАПИЛЬНИКИ, РАШПИЛИ, МЕТЧИКИ

LIMAS CUADRADAS / SQUARE FILES / LIMES CARREES / VIERKANTFEILEN / LIMA QUADRA / LIMATÕES QUADRADOS / КВАДРАТНЫЕ НАПИЛЬНИКИ

COD.	L (inch)	M/cm			A (mm)		
63635	4	1	14	85	4,0	18	
63636		2	22				
63637		3	28				
63638	6	1	11	114	6,0	36	5
63639		2	18				
63640		3	22				
63641	8	1	10	135	8,0	95	
63642		2	16				
63643		3	20				
63644	10	1	9	114	10	130	5
63645		2	12				
63646		3	18				
63647	12	1	8	135	12	390	
63648		2	11				
63649		3	16				
63650	14	1	7	135	15	550	
63651		2	10				
63652		3	14				

1 : Basta / Bastard / Bâtarde
 2 : Entrefina / Medium / Demi-douce
 3 : Fina / Smooth / Douce



ISO 234/1 - ISO 234/2

ESPECIFICACIONES TÉCNICAS / TECHNICAL SPECIFICATION / DÉTAILS TECHNIQUES

Tolerancia en corte según la norma / Cutting tolerance according to / Tolérance de coupe conforme à la norme ISO 234/2 (+/- 8%)

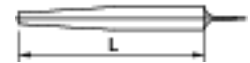
Ángulo de corte según la norma / Angle cut according to / Angle de coupe conforme à la norme ISO 234/2 (65° +/- 5%)

LIMAS REDONDAS / ROUND FILES / LIMES RONDES / RUNDFEILEN / LIMA TONDA / LIMATÕES REDONDOS / КРУГЛЫЕ НАПИЛЬНИКИ

COD.	L (inch)	M/cm			A (mm)		
63671	4	1	13	85	4,0	13	
63672		2	16				
63673		3	19				
63674	6	1	11	114	6,0	34	5
63675		2	14				
63676		3	17				
63677	8	1	10	135	7,5	75	
63678		2	13				
63679		3	16				
63680	10	1	9	114	9,5	150	5
63681		2	12				
63682		3	15				
63683	12	1	8	135	12	270	
63684		2	11				
63685		3	14				
63686	14	1	7	135	15	550	
63687		2	10				
63688		3	13				

1 : Basta / Bastard / Bâtarde
 2 : Entrefina / Medium / Demi-douce
 3 : Fina / Smooth / Douce

ISO 234/1 - ISO 234/2

ESPECIFICACIONES TÉCNICAS / TECHNICAL SPECIFICATION / DÉTAILS TECHNIQUES



Tolerancia en corte según la norma / Cutting tolerance according to / Tolérance de coupe conforme à la norme ISO 234/2 (+/- 8%)

Ángulo de corte según la norma / Angle cut according to / Angle de coupe conforme à la norme ISO 234/2 (65° +/- 5%)

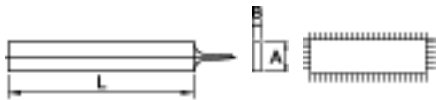

14

LIMAS, ESCOFINAS, BOTADORES Y GRANETES*FILES, RASPS & PUNCHES***LIMES, RAPES, POINTEAUX ET CHASSES GOUPILLES***FEILEN, RASPELN, DURCHSCHLÄGER UND KÖRNER***LIMA, RASPE E PUNZONI***LIMAS, GROSAS E PUNÇÕES***НАПИЛЬНИКИ, РАШПИЛИ, МЕТЧИКИ**■ **LIMA PLANA / FARMER'S OWN / LIME PLATE / FLACHFEILEN / LIMA PIATTA / LIMA PLANA / ФЕРМЕРСКИЙ НАПИЛЬНИК**

COD.	L (inch)		 /cm	A (mm)	B (mm)	 g	
63689	8	2	16	25	5,0	230	10

2 : Entrefina / Medium / Demi-douce

ISO 234/1 - ISO 234/2

■ **JUEGOS / SETS / JEUX / SÄTZE / ASSORTIMENTI / JOGOS / НАБОРЫ**

JUEGO DE 5 LIMAS DE 10" BASTA / 10" BASTARD FILE SET 5 PCS / JEU DE 5 LIMES BATARDES 10" / SET BASTARD FEILEN 5 STÜCK / KIT 5 LIME BASTARDE 10" / JOGO DE 5 LIMAS DE 10" BASTARDAS / 10" ГРУБЫЕ НАПИЛЬНИКИ НАБОР ИЗ 5 ШТ

COD.	PCS.
63760	5

PCS./UN.	COD.	PCS.	Descripción / Description / Description	L (inch)
	63536		Lima plana punta basta / Bastard flat file	
	63572		Lima media caña basta / Bastard half round file	
1	63608		Lima triangular basta / Bastard triangular file	10
	63644		Lima cuadrada basta / Bastard square file	
	63680		Lima redonda basta / Bastard round file	



JUEGO DE 5 LIMAS DE 10" ENTREFINA / 10" MEDIUM FILE SET 5 PCS / JEU DE 5 LIMES DEMI-DOUCES 10" / SET MEDIUM FEILEN 5 STÜCK / KIT 5 LIME EXTRA FINE 10" / JOGO DE 5 LIMAS 10" MEIO MURÇO / 10" СРЕДНИЕ НАПИЛЬНИКИ НАБОР ИЗ 5 ШТ

COD.	PCS.
63762	5

PCS./UN.	COD.	PCS.	Descripción / Description / Description	L (inch)
	63537		Lima plana punta entrefina / Medium flat file	
	63573		Lima media caña entrefina / Medium half round file	
1	63609		Lima triangular entrefina / Medium triangular file	10
	63645		Lima cuadrada entrefina / Medium square file	
	63681		Lima redonda entrefina / Medium round file	



14

LIMAS, ESCOFINAS, BOTADORES Y GRANETES*FILES, RASPS & PUNCHES***LIMES, RAPES, POINTEAUX ET CHASSES GOUPILLES***FEILEN, RASPELN, DURCHSCHLÄGER UND KÖRNER***LIMA, RASPE E PUNZONI***LIMAS, GROSAS E PUNÇÕES***НАПИЛЬНИКИ, РАШПИЛИ, МЕТЧИКИ****JUEGO DE 5 LIMAS DE 10" FINA / 10" SMOOTH FILE SET 5 PCS / JEU DE 5 LIMES DOUCES 10" / SET SCHLICHT FEILEN 5 STÜCK / KIT 5 LIME FINE 10" / JOGO DE 5 LIMAS 10" MURÇO / 10" МЕЛКИЕ НАПИЛЬНИКИ НАБОР ИЗ 5 ШТ**

COD.		PCS.	
63767		5	

PCS./UN.	COD.	PCS.	Descripción / Description / Description	L (inch)
	63538		Lima plana punta fina / Smooth flat file	
	63574		Lima media caña fina / Smooth half round file	
1	63610		Lima triangular fina / Smooth triangular file	10
	63646		Lima cuadrada fina / Smooth square file	
	63682		Lima redonda fina / Smooth round file	

**LIMAS AFILADO / SHARPENING FILES / LIMES AIGUILLES / PRÄZISIONSNADELFEILEN DÜNN / LIMA AFFILATA / LIMAS DE AFIAR, DE AGRICULTOR / ЗАТАЧИВАЮЩИЕ НАПИЛЬНИКИ****LIMA TRIANGULAR DELGADA / SLIM TAPER SAW / LIME TRIANGULAIRE ETROITE / PRÄZISIONSNADELFEILEN DÜNN / LIMA TRIANGOLARE / LIMAS TRIANGULARES FINAS / ТРЕУГОЛЬНЫЙ НАПИЛЬНИК**

COD.	L (inch)		A (mm)		
63692	4	4	85	4,5	10
63693	5			6,0	25

4: Extrafina / Very smooth / Extrafine

ISO 234/1 - ISO 234/2

**LIMA TRIANGULAR EXTRA-DELGADA / EXTRA REGULAR TAPER SAW / LIME EXTRA FINE / DREIKANTFEILEN / LIMA TRIANGOLARE EXTRA-SOTTILE / LIMAS TRIANGULARES EXTRA-FINAS / МЕЛКИЙ ТРЕУГОЛЬНЫЙ НАПИЛЬНИК**

COD.	L (inch)		A (mm)		
63696	4	4	85	4,0	10
63697	5			5,0	20

4: Extrafina / Very smooth / Extrafine

ISO 234/1 - ISO 234/2

**ESCOFINAS / RASPS / RAPES / SCHABER / RASPA / GROSAS / РАШПИЛИ****ESCOFINAS PLANAS PARALELAS / HAND WOOD RASPS / RAPES PLATES PARALLELES / FLACH RAPES / RASPA PIATTA PARALLELA / GROSAS PARALELAS / РУЧНЫЕ РАШПИЛИ ПО ДЕРЕВУ**

COD.	L (inch)	W/cm	A (mm)	B (mm)			
63700	10	3	115	24	7,0	125	5
63701	12		135	28	8,0	220	1

ISO 234/1 - ISO 234/2



14

LIMAS, ESCOFINAS, BOTADORES Y GRANETES

FILES, RASPS & PUNCHES

LIMES, RAPES, POINTEAUX ET CHASSES GOUPILLES

FEILEN, RASPELN, DURCHSCHLÄGER UND KÖRNER

LIMA, RASPE E PUNZONI

LIMAS, GROSAS E PUNÇÕES

НАПИЛЬНИКИ, РАШПИЛИ, МЕТЧИКИ

■ **ESCOFINAS REDONDAS / ROUND RASPS / RAPES RONDES / RUNDE RAPPS / RASPA TONDA / GROSAS REDONDAS / КРУГЛЫЕ РАШПИЛИ**



COD.	L (inch)	Λ/cm		A (mm)		
63712	8	3	114	9,5	60	5
63713	10			11	125	

ISO 234/1 - ISO 234/2



■ **ESCOFINAS MEDIA CAÑA / HALF ROUND RASPS / RAPES DEMI-ROND / HALBRUND RAPPS / RASPA MEZZOTANDA / GROSAS MEIA CANA / ПОЛУКРУГЛЫЙ РАШПИЛЬ**

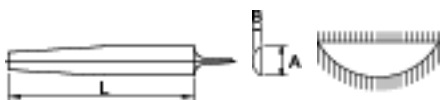

COD.	L (inch)	Λ/cm		A (mm)	B (mm)		
63706	6	3	85	16	4,0	80	5
63707	8			20	5,5	140	
63708	10			24	7,0	240	
63709	12			28	8,0	370	

ISO 234/1 - ISO 234/2



■ **LIMAS DE AGUJA / NEEDLE FILES / LIMES AIGUILLES / NADELFEILEN / LIMA A PUNTA / LIMAS DE CALADO / НАДФИЛИ**

■ **LIMAS PLANAS PARALELAS / HAND FILES / LIMES PLATES PARALLELES / FLACHSTUMPF / LIMA PIATTA PARALLELA / LIMAS PARALELAS / РУЧНОЙ НАДФИЛЬ**



COD.	L (inch)	Λ/cm	A (mm)	B (mm)				
63714	6	2	25	16	3,3	70	24	I

2: Entrefina / Medium / Demi-douce

ISO 234/1 - ISO 234/2



■ **LIMAS PLANAS DE PUNTA / FLAT FILES / LIMES PLATES DE BOUT / NADELFLACHSTUMPF / LIMA PIATTA A PUNTA / LIMAS CHATAS / ПЛОСКИЙ НАДФИЛЬ**

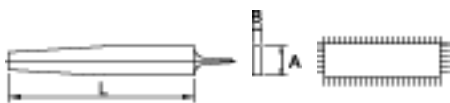

COD.	L (inch)	Λ/cm	A (mm)	B (mm)				
63715	6	2	25	16	3,3	65	24	I

2: Entrefina / Medium / Demi-douce

ISO 234/1 - ISO 234/2



■ **LIMAS MEDIA CAÑA / HALF ROUND FILES / LIMES DEMI-RONDES / HALBRUND-FEILEN / LIMA MEZZATONDA / LIMAS MEIA CANA / ПОЛУКРУГЛЫЙ НАДФИЛЬ**

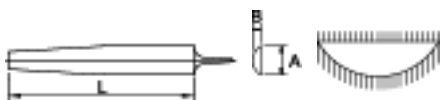

COD.	L (inch)	Λ/cm	A (mm)	B (mm)				
63716	6	2	25	16	4,2	65	24	I

2: Entrefina / Medium / Demi-douce

ISO 234/1 - ISO 234/2



14

LIMAS, ESCOFINAS, BOTADORES Y GRANETES
FILES, RASPS & PUNCHES
LIMES, RAPES, POINTEAUX ET CHASSES GOUPILLES
FEILEN, RASPELN, DURCHSCHLÄGER UND KÖRNER
LIMA, RASPE E PUNZONI
LIMAS, GROSAS E PUNÇÕES
НАПИЛЬНИКИ, РАШПИЛИ, МЕТЧИКИ

■ **LIMAS REDONDAS / ROUND FILES / LIMES RONDES / RUNDFEILEN / LIMA TONDA / LIMATÕES REDONDOS / КРУГЛЫЙ НАДФИЛЬ**



COD.	L (inch)		W/cm	A (mm)	g		
63717	6	2	25	5,5	30	24	I

2 : Entrefina / Medium / Demi-douce
 ISO 234/1 - ISO 234/2



■ **LIMAS TRIANGULARES / TRIANGULAR FILES / LIMES TRIANGULAIRES / DREIKANTFEILEN / LIMA TRIANGOLARE / LIMAS TRIANGULARES / ТРЕУГОЛЬНЫЙ НАДФИЛЬ**



COD.	L (inch)		W/cm	A (mm)	g		
63718	6	2	25	11	60	24	I

2 : Entrefina / Medium / Demi-douce
 ISO 234/1 - ISO 234/2



■ **LIMAS CUADRADAS / SQUARE FILES / LIMES CARRÉES / VIERKANTFEILEN / LIMA QUADRA / LIMATÕES QUADRADOS / КВАДРАТНЫЙ НАДФИЛЬ**



COD.	L (inch)		W/cm	A (mm)	g		
63719	6	2	25	5,0	35	24	I

2 : Entrefina / Medium / Demi-douce
 ISO 234/1 - ISO 234/2



■ **SET**

COD.	PCS.
63768	6

PCS./UN.	COD. PCS.	L (inch)
1	63714	6
	63715	
	63716	
	63717	
	63718	
	63719	



■ **BOTADORES CILÍNDRICOS / PIN PUNCHES / CHASSES GOUPILLES / DURCHSCHLÄGER / PUNZONE CILINDRICO / PUNÇÕES CILÍNDRICOS / ПРОБОЙНИКИ**

■ **MOLETEADOS / KNURLED / MOLETAGE / GERÄNDELT / ZIGRINATO / RECARTILHADOS / С НАСЕЧКОЙ**

COD.	D (mm)	L (mm)	A (mm)	g	
63380	2	125	8	40	25
63381	3			41	
63382	4			43	
63383	5		10	65	
63384	6			90	
63385	8			125	
63386	10	14	125		

DIN 6450

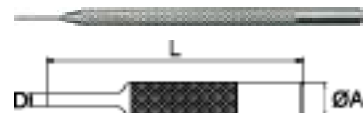

CARACTERÍSTICAS / FEATURES / CARACTÉRISTIQUES

Cr-V

14

LIMAS, ESCOFINAS, BOTADORES Y GRANETES
 FILES, RASPS & PUNCHES
 LIMES, RAPES, POINTEAUX ET CHASSES GOUPILLES
 FEILEN, RASPELN, DURCHSCHLÄGER UND KÖRNER
 LIMA, RASPE E PUNZONI
 LIMAS, GROSAS E PUNÇÕES
 НАПИЛЬНИКИ, РАШПИЛИ, МЕТЧИКИ

SET

COD.	PCS.
68590	7

PCS./UN.	COD. PCS.	D (mm)
1	63380	2
	63381	3
	63382	4
	63383	5
	63384	6
	63385	8
	63386	10



MOLETEADOS LARGOS / LONG KNURLED / LONG MOLETAGE / LANG GERÄNDEL / ZIGRINATO LARGO / RECARTILHADOS LONGOS / ДЛИННЫЕ С НАСЕЧКОЙ

COD.	D (mm)	L (mm)	A (mm)	g	Icon
63387	2	150	8	49	25
63388	3			50	
63389	4			55	
63390	5		10	75	
63391	6		12	80	
63392	8		14	115	
63393	10			160	

DIN 6450

CARACTERÍSTICAS / FEATURES / CARACTÉRISTIQUES

Cr-V

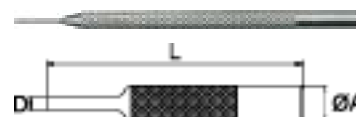

SET

COD.	PCS.
68591	7

PCS./UN.	COD. PCS.	D (mm)
1	63387	2
	63388	3
	63389	4
	63390	5
	63391	6
	63392	8
	63393	10



HEXAGONALES / HEXAGONAL / A SIX PANS / HEXAGONAL / ESAGONALI / HEXAGONAIS / ШЕСТИГРАННАЯ

COD.	D (mm)	L (mm)	A (mm)	g	Icon
63394	2	150	8,0	28	25
63395	3			40	
63396	4			42	
63397	5		10	65	
63398	6		12	70	
63399	8			90	
63400	10			95	

DIN 6450

CARACTERÍSTICAS / FEATURES / CARACTÉRISTIQUES

Cr-V

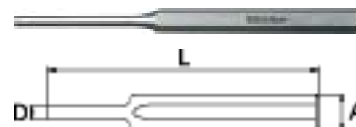

14

LIMAS, ESCOFINAS, BOTADORES Y GRANETES
FILES, RASPS & PUNCHES
LIMES, RAPES, POINTEAUX ET CHASSES GOUPILLES
FEILEN, RASPELN, DURCHSCHLÄGER UND KÖRNER
LIMA, RASPE E PUNZONI
LIMAS, GROSAS E PUNÇÕES
НАПИЛЬНИКИ, РАШПИЛИ, МЕТЧИКИ

SET

COD.	PCS.
63763	7

PCS./UN.	COD. PCS.	D (mm)
1	63394	2
	63395	3
	63396	4
	63397	5
	63398	6
	63399	8
	63400	10



OCTOGONAL / OCTOGONAL / ОКТОГОНАЛ / OCTOGONAL / OTTAGONALE / OCTOGONAIS / ВОСЬМИГРАННЫЕ

COD.	D (mm)	L (mm)	A (mm)		
63401	2	150	10	65	25
63402	3				
63403	4				
63404	5				
63405	6				
63406	8				
63407	10				

DIN 6450

CARACTERÍSTICAS / FEATURES / CARACTÉRISTIQUES

Cr-V

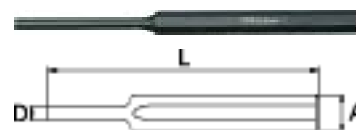

SET

COD.	PCS.
68592	7

PCS./UN.	COD. PCS.	D (mm)
1	63401	2
	63402	3
	63403	4
	63404	5
	63405	6
	63406	8
	63407	10



CON MANGO / WITH HANDLE / AVEC MANCHE / MIT GRIFF / CON MANICO / COM CABO / С РУКОЯТКОЙ

COD.	D (mm)	L (mm)	A (mm)		
63447	2	165	8	65	10
63448	3	175			
63449	4	185	10	100	
63450	5	200			
63451	6	210	12	150	
63452	7				
63453	8	220	14	170	
63454	9				
63455	10	230	16	240	
63456	12				
63457	14	240	18	430	
63458	16				

DIN 6450

CARACTERÍSTICAS / FEATURES / CARACTÉRISTIQUES

Cr-V





14

LIMAS, ESCOFINAS, BOTADORES Y GRANETES
FILES, RASPS & PUNCHES
LIMES, RAPES, POINTEAUX ET CHASSES GOUPILLES
FEILEN, RASPELN, DURCHSCHLÄGER UND KÖRNER
LIMA, RASPE E PUNZONI
LIMAS, GROSAS E PUNÇÕES
НАПИЛЬНИКИ, РАШПИЛИ, МЕТЧИКИ

■ **BOTADORES CÓNICOS / TAPER PUNCHES / CHASSE CLOU / KÖRNER / PUNZONE CONICO / PUNÇÕES CÓNICOS / КОНИЧЕСКИЕ ПРОБОЙНИКИ**

■ **MOLETEADOS / KNURLED / MOLETAGE / GERÄNDEL / ZIGRINATO / RECARILHADOS / С НАСЕЧКОЙ**

COD.	D (mm)	L (mm)	A (mm)		
63408	2	125	8	44	25
63409	3			45	
63410	4			47	
63411	5	125	10	70	25
63412	6			100	
63413	8			130	
63414	10				

DIN 6458

CARACTERÍSTICAS / FEATURES / CARACTÉRISTIQUES

Cr-V



■ **SET**

COD.	PCS.
68593	7

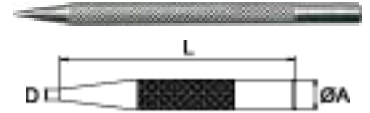
PCS./UN.	COD. PCS.	D (mm)
1	63408	2
	63409	3
	63410	4
	63411	5
	63412	6
	63413	8
	63414	10



■ **HEXAGONALES / HEXAGONAL / A SIX PANS / HEXAGONAL / ESAGONALI / HEXAGONAIS / ШЕСТИГРАННАЯ**

COD.	D (mm)	L (mm)	A (mm)		
63415	2	125	10	60	25
63416	3			65	
63417	4			70	
63418	5	150	12	110	25
63419	6			120	
63420	8				
63421	10				

DIN 6458

CARACTERÍSTICAS / FEATURES / CARACTÉRISTIQUES

Cr-V



■ **SET**

COD.	PCS.
63764	7

PCS./UN.	COD. PCS.	D (mm)
1	63415	2
	63416	3
	63417	4
	63418	5
	63419	6
	63420	8
	63421	10





■ **OCTOGONAL / OCTOGONAL / ОКТОГОНАЛ / OCTOGONAL / OTTAGONALE / OCTOGONAIS / ВОСЬМИГРАННЫЕ**

COD.	D (mm)	L (mm)	A (mm)		
63422	2	120	10	60	25
63423	3			65	
63424	4	150		75	



14

LIMAS, ESCOFINAS, BOTADORES Y GRANETES
FILES, RASPS & PUNCHES
LIMES, RAPES, POINTEAUX ET CHASSES GOUPILLES
FEILEN, RASPELN, DURCHSCHLÄGER UND KÖRNER
LIMA, RASPE E PUNZONI
LIMAS, GROSAS E PUNÇÕES
НАПИЛЬНИКИ, РАШПИЛИ, МЕТЧИКИ

COD.	D (mm)	L (mm)	A (mm)		
63425	5	150	10	80	25
63426	6				
63427	8				
63428	10				

DIN 6458

CARACTERÍSTICAS / FEATURES / CARACTÉRISTIQUES

Cr-V



SET

COD.	PCS.
68594	7

PCS./UN.	COD. PCS.	D (mm)
1	63422	2
	63423	3
	63424	4
	63425	5
	63426	6
	63427	8
	63428	10



CON MANGO / WITH HANDLE / CHASSE CLOU EMMENCHÉ / MIT GRIFF / CON MANICO / COM CABO / С РУКОЯТКОЙ

COD.	D (mm)	L (mm)	A (mm)		
63459	2	165	8	75	10
63460	3	175		80	
63461	4	185		110	
63462	5		10	115	
63463	6		120		
63464	8	12	170	200	
63465	10		200		

DIN 6458



CARACTERÍSTICAS / FEATURES / CARACTÉRISTIQUES

Cr-V



GRANETES / CENTER PUNCHES / POINTEAUX / KÖRNER / PUNZONI / PUNÇÕES / МЕТЧИКИ

MOLETEADOS / KNURLED / MOLETAGE / GERÄNDEL / ZIGRINATO / RECARTILHADOS / С НАСЕЧКОЙ

COD.	D (mm)	L (mm)	A (mm)			
63429	2,5	125	10	42	25	
63430	3			8		43
63431	4			45		
63432	6			70		
63433	8			100		
63434	10			14		130

DIN 7250

CARACTERÍSTICAS / FEATURES / CARACTÉRISTIQUES

Cr-V



14

LIMAS, ESCOFINAS, BOTADORES Y GRANETES
 FILES, RASPS & PUNCHES
 LIMES, RAPES, POINTEAUX ET CHASSES GOUPILLES
 FEILEN, RASPELN, DURCHSCHLÄGER UND KÖRNER
 LIMA, RASPE E PUNZONI
 LIMAS, GROSAS E PUNÇÕES
 НАПИЛЬНИКИ, РАШПИЛИ, МЕТЧИКИ



SET

COD.	PCS.
68595	6

PCS./UN.	COD. PCS.	D (mm)
1	63429	2,5
	63430	3
	63431	4
	63432	6
	63433	8
	63434	10



HEXAGONALES / HEXAGONAL / A SIX PANS / HEXAGONAL / ESAGONALI / HEXAGONAIS / ШЕСТИГРАННАЯ

COD.	D (mm)	L (mm)	A (mm)		
63435	2,5				
63436	3	100	8	35	
63437	4	115		40	25
63438	6	125	10	70	
63439	8	150		120	
63440	10	160	12	130	

DIN 7250

CARACTERÍSTICAS / FEATURES / CARACTÉRISTIQUES

Cr-V

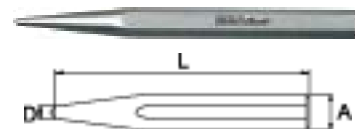



SET

COD.	PCS.
63765	6

PCS./UN.	COD. PCS.	D (mm)
1	63435	2,5
	63436	3
	63437	4
	63438	6
	63439	8
	63440	10



OCTOGONAL / OCTOGONAL / ОКТОГОНАЛ / OCTOGONAL / OTTAGONALE / OCTOGONAIS / ВОСЬМИГРАННЫЕ

COD.	D (mm)	L (mm)	A (mm)		
63441	2,5			60	
63442	3				
63443	4	120	10	65	25
63444	6				
63445	8		12	95	
63446	10			105	

DIN 7250

CARACTERÍSTICAS / FEATURES / CARACTÉRISTIQUES

Cr-V

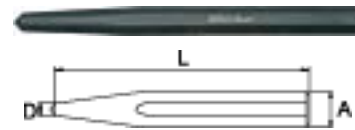

SET

COD.	PCS.
68596	6



PCS./UN.	COD. PCS.	D (mm)
1	63441	2,5
	63442	3
	63443	4
	63444	6
	63445	8
	63446	10



14

LIMAS, ESCOFINAS, BOTADORES Y GRANETES
FILES, RASPS & PUNCHES
LIMES, RAPES, POINTEAUX ET CHASSES GOUPILLES
FEILEN, RASPELN, DURCHSCHLÄGER UND KÖRNER
LIMA, RASPE E PUNZONI
LIMAS, GROSAS E PUNÇÕES
НАПИЛЬНИКИ, РАШПИЛИ, МЕТЧИКИ

■ **CON MANGO / WITH HANDLE / POINTEAU EMMENCHÉ / MIT GRIFF / CON MANICO / COM CABO / С РУКОЯТКОЙ**

COD.	D (mm)	L (mm)	A (mm)		
63466	2	165	8	75	10
63467	3				
63468	4	175	10	115	
63469	5				
63470	6				
63471	8	185	12	165	

DIN 7250

CARACTERÍSTICAS / FEATURES / CARACTÉRISTIQUES

Cr-V

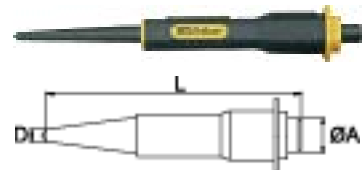

■ **SET**

■ **CINCELES, BOTADORES Y GRANETES / CHISELS AND PUNCHES / BURINS, CHASSE-GOUPILLES, CHASSE-CLOUS / MEISSEL UND DURCHSCHLÄGE / SCALPELLI E PUNZONI / ESCOPROS, SACA-TROÇOS E PUNÇÕES / ДОЛОТА И ПРОБойНИКИ**

■ **6 PCS.**

COD.	PCS.	
69953	6	700

PCS./UN.	COD.	PCS.	Descripción / Description / Description	
1	62847	1	Cinzel mecánico / Flat cold chisel	12 x 11 x 100 mm
	62848			15 x 14 x 125 mm
	63398	1	Botador cilíndrico / Pin punch	6 x 10 x 150 mm
	63396			4 x 8 x 150 mm
	63416			3 x 10 x 125 mm
	63436	1	Granete / Center punch	3 x 8 x 100 mm



COD.	PCS.	
69954	6	700

PCS./UN.	COD.	PCS.	Descripción / Description / Description	
1	62847	1	Cinzel mecánico / Flat cold chisel	12 x 11 x 100 mm
	62848			15 x 14 x 125 mm
	62871	1	Burril plano / Crosscut chisel	5 x 14 x 125 mm
	63396			4 x 8 x 150 mm
	63416			3 x 10 x 125 mm
	63436	1	Granete / Center punch	3 x 8 x 100 mm



■ **BOTADORES CILÍNDRICOS / PIN PUNCHES / CHASSE GOUPILLES / RUNDDURCHSCHLÄGER / PUNZONE CILINDRICO / PUNÇÕES CILÍNDRICOS / ПРОБойНИКИ**

■ **6 PCS.**

COD.	PCS.	
69957	6	500

PCS./UN.	COD.	PCS.	Descripción / Description / Description	
1	63394	1	Botador cilíndrico / Pin punch	2 x 8 x 100 mm
	63395			3 x 8 x 150 mm
	63396			4 x 8 x 150 mm
	63397			5 x 10 x 150 mm
	63398			6 x 10 x 150 mm
	63399			8 x 12 x 150 mm



14

LIMAS, ESCOFINAS, BOTADORES Y GRANETES
FILES, RASPS & PUNCHES
LIMES, RAPES, POINTEAUX ET CHASSES GOUPILLES
FEILEN, RASPELN, DURCHSCHLÄGER UND KÖRNER
LIMA, RASPE E PUNZONI
LIMAS, GROSAS E PUNÇÕES
НАПИЛЬНИКИ, РАШПИЛИ, МЕТЧИКИ

COD.	PCS.	
69958	6	700

PCS./UN.	COD.	PCS.	Descripción / Description / Description	
	63394			2 x 8 x 100 mm
	63395			3 x 8 x 150 mm
1	63396		Botador cilíndrico / Pin punch	4 x 8 x 150 mm
	63397			5 x 10 x 150 mm
	63398			6 x 10 x 150 mm
	63399			8 x 12 x 150 mm



■ BOTADORES Y GRANETES / PUNCHES / POINTEAUX / DURCHSCHLÄGE / PUNZONI / SACA-TROÇOS E PUNÇÕES / ПРОБЙНИКИ

■ 6 PCS.

COD.	PCS.	
69955	6	700

PCS./UN.	COD.	PCS.	Descripción / Description / Description	
	63415			2 x 10 x 125 mm
	63416			3 x 10 x 125 mm
1	63417		Botador cónico / Taper punch	4 x 10 x 125 mm
	63418			5 x 10 x 125 mm
	63419			6 x 10 x 125 mm
	63437		Granete / Center punch	4 x 8 x 100 mm



COD.	PCS.	
69956	6	750

PCS./UN.	COD.	PCS.	Descripción / Description / Description	
	63415			2 x 10 x 125 mm
	63416			3 x 10 x 125 mm
1	63417		Botador cónico / Taper punch	4 x 10 x 125 mm
	63418			5 x 10 x 125 mm
	63419			6 x 10 x 125 mm
	63437		Granete / Center punch	4 x 8 x 100 mm



■ 60 PCS.

COD.	PCS.	
55565	60	4

PCS./UN.	COD.	PCS.	Descripción / Description / Description	
	63415			2 x 10 x 125 mm
	63416			3 x 10 x 125 mm
	63417		Botador cónico / Taper punch	4 x 10 x 125 mm
	63418			5 x 10 x 125 mm
	63419			6 x 10 x 125 mm
5	63438		Granete / Center punch	8 x 12 x 150 mm
	63439			8 x 12 x 150 mm
	63394			2 x 8 x 100 mm
	63395			3 x 8 x 150 mm
	63396		Botador cilíndrico / Pin punch	4 x 8 x 150 mm
	63397			5 x 10 x 150 mm
	63398			6 x 10 x 150 mm

